

GoodWe Storage Solutions



GOODWE
YOUR SOLAR ENGINE

YOUR SOLAR ENGINE

Requirements for Battery Install.

Grid Connect Battery Backup System

When installing a grid connect battery backup system the installation **shall** be performed by a person with CEC grid connected install accreditation with battery backup endorsement.

Note: The installation of battery storage has additional safety risks associated with their installation.

 Electric shock hazard

 Energy hazard

 Chemical hazard

In order to install Grid Connected Battery Storage, you **must** be endorsed to do so.

To become endorsed to install grid-connected battery storage, accreditation must also be held for the design and install of grid-connected (GC) photovoltaic systems

Standards Compliance

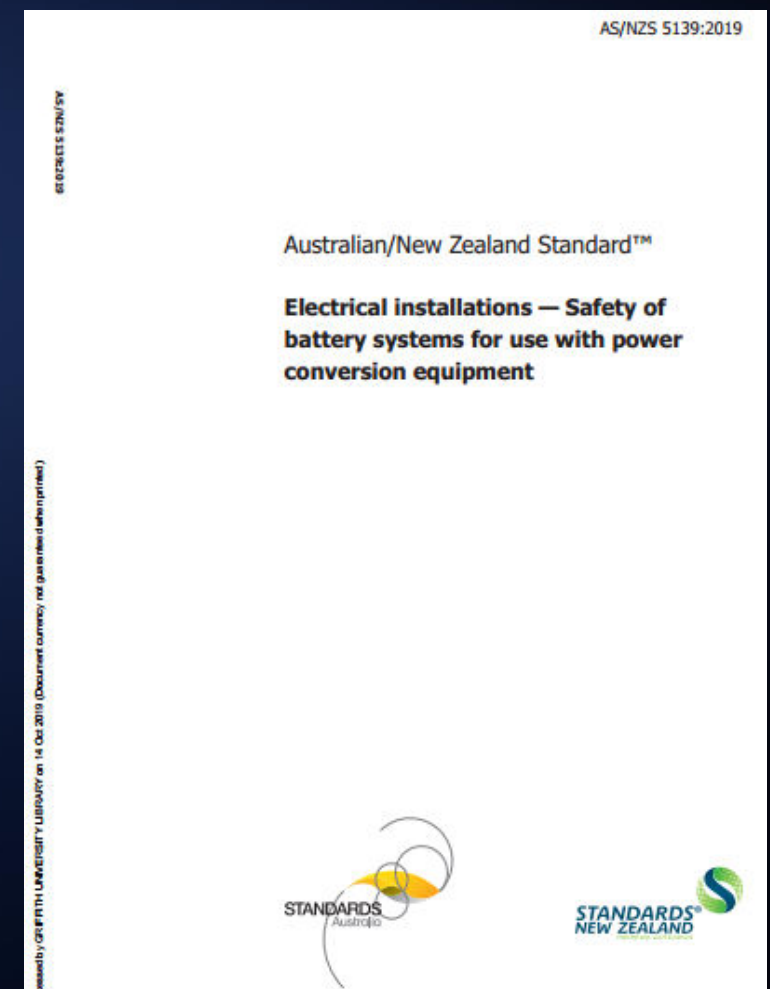
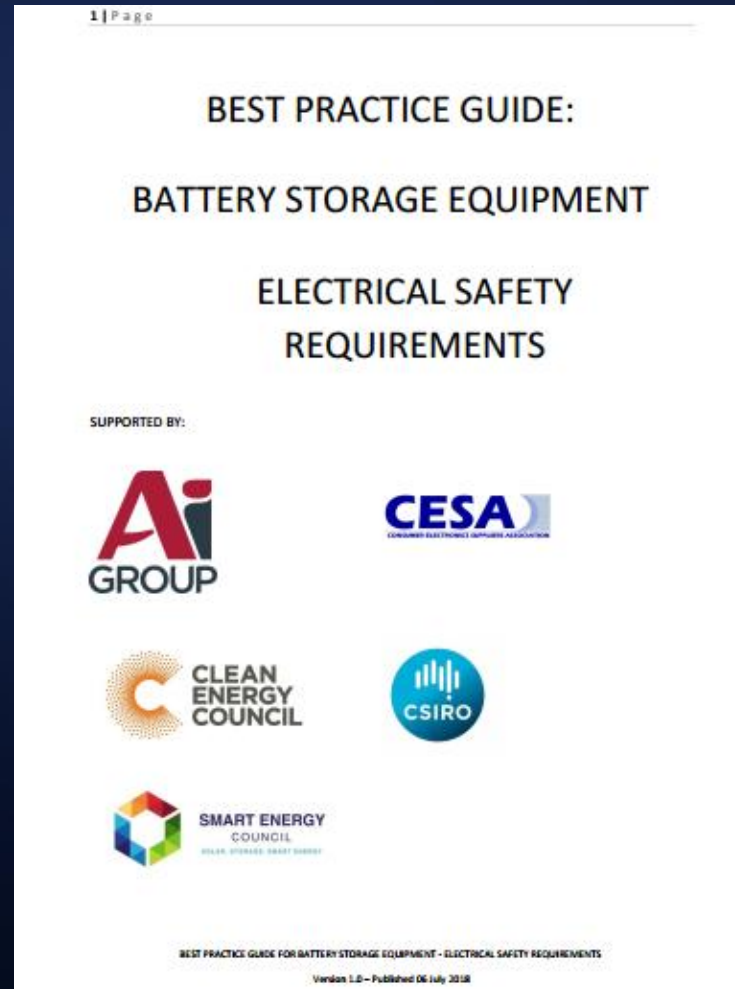

AS/NZS 3000, Best Practice Guide, AS/NZS 5139
Goodwe storage inverter with external battery belongs to BS (section 5 in AS/NZS 5139)

01

Available solutions

Single Phase House

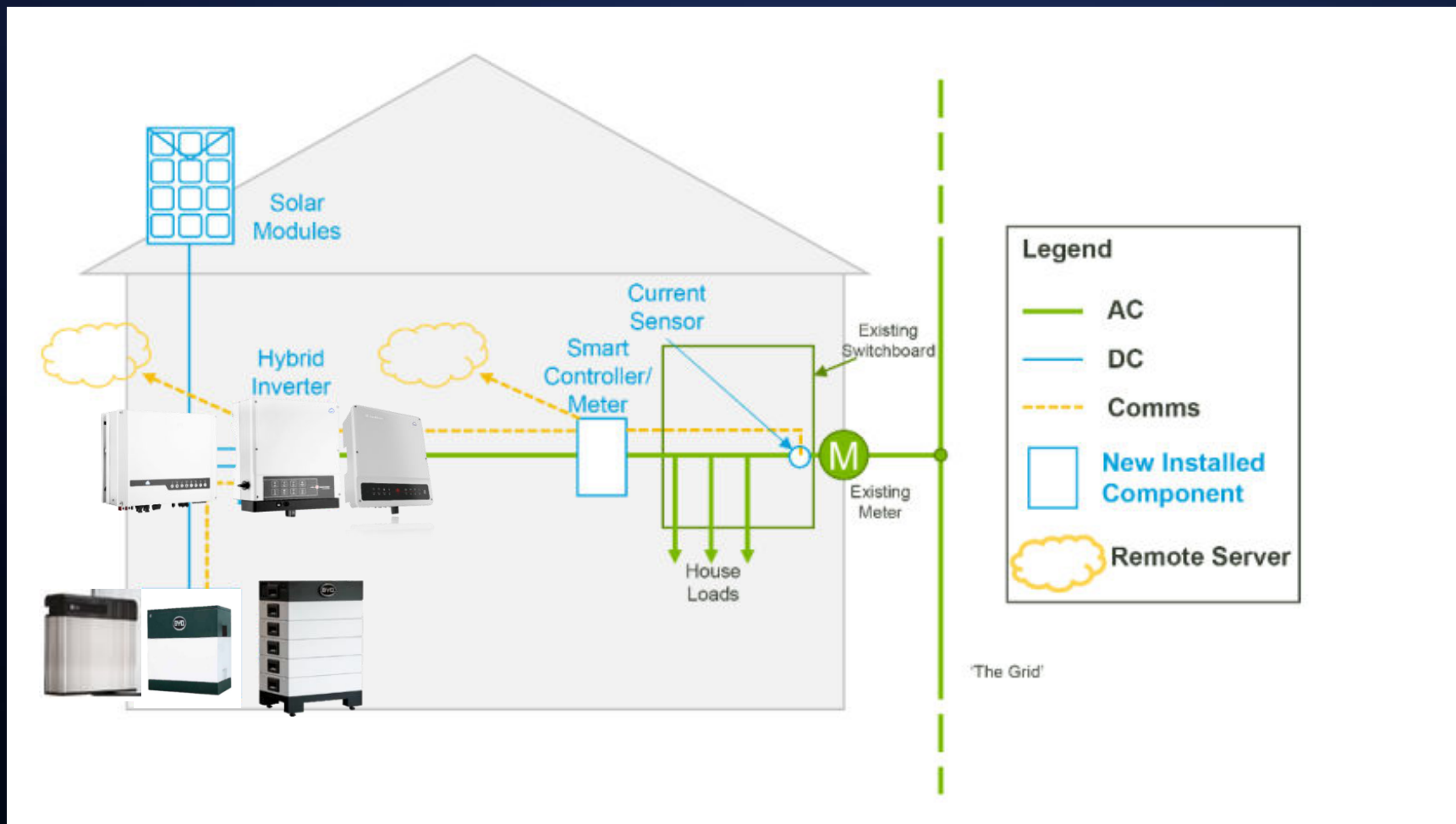

Premier solution:

GW5048D-ES

- 100A charge/discharge with 20A
- back up plus Low Voltage BYD or LG

Economic solution:

GW3048-EM or GW5048-EM

- 50A charge/discharge with 10A
- back up plus Low Voltage BYD or LG

High Voltage battery solution:

GW3600-EH or GW5000-EH

- 20A back up with High Voltage BYD

Existing Solar (single or three phases)

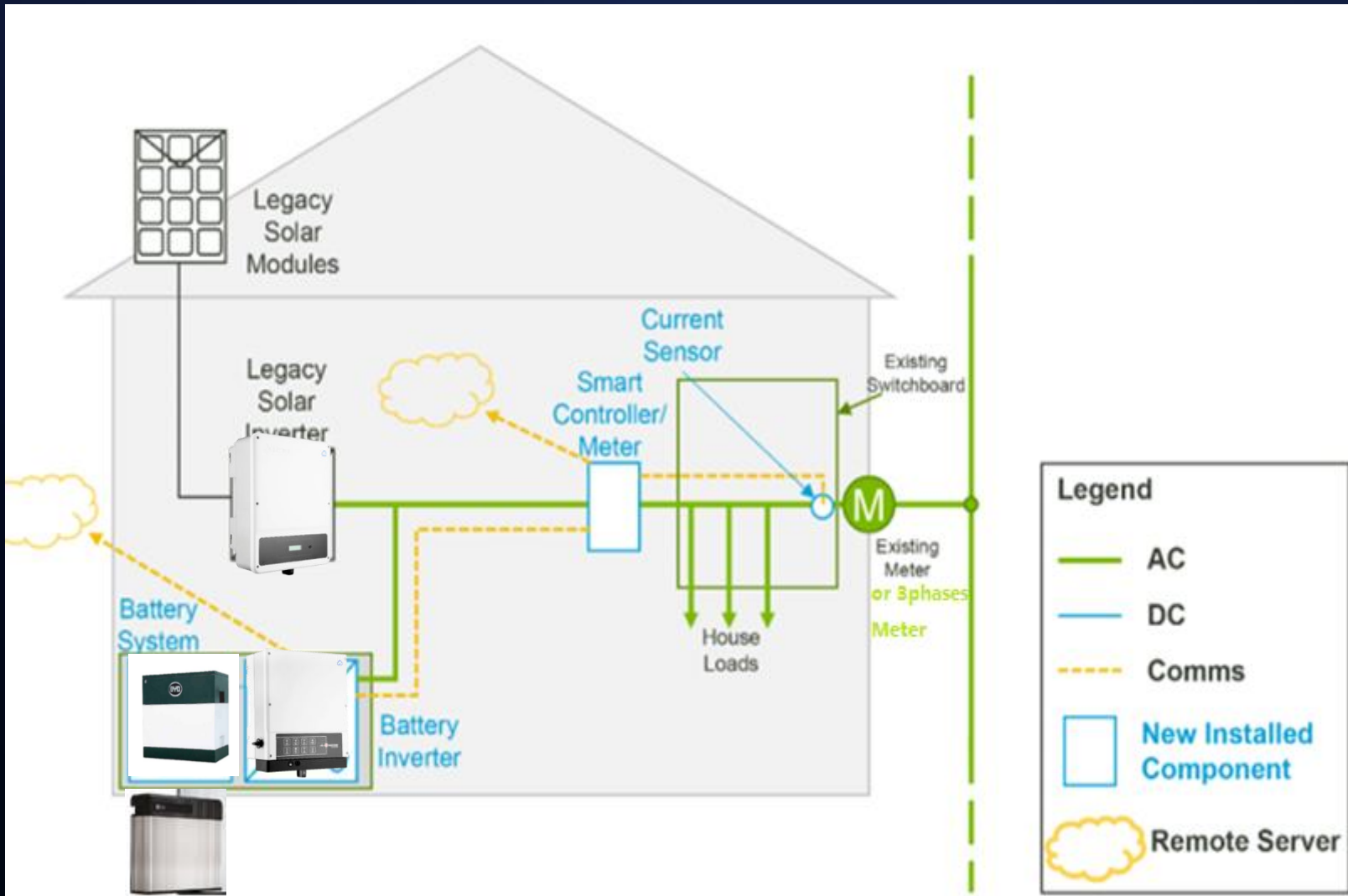

Single phase AC Retrofit:

SBP5000

- 100A charge/discharge with 20A back up
- Low Voltage BYD and LG

Three phases AC Retrofit:

GW5000S-BP

- 100A charge/discharge with 20A back up with GM3000
- LV BYD and LG

Three Phases House

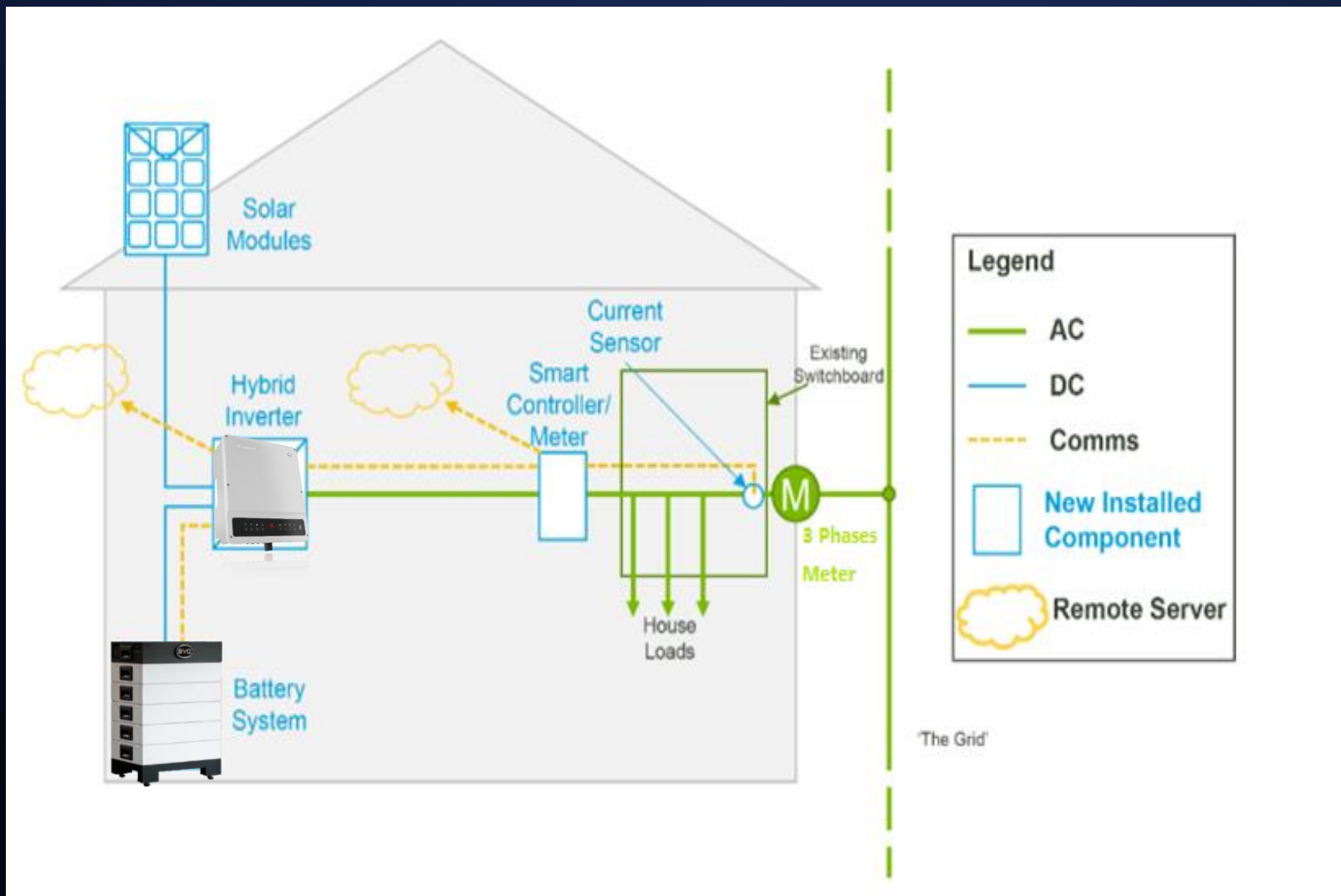

Three phases Solution:

GW5KL-ET or GW10kL- ET

- 5kW or 10kW back up power
- High Voltage BYD

Low Voltage battery solution:

GW5048D-ES, GW5048-EM

- GM3000 meter
- Low Voltage BYD and LG

02

System design

PV Side: oversizing

GW5048D-ES, GW5048-EM, GW5000-EH, GW5KL-ET, GW10KL-ET,
are all support **33% of AC oversizing** which is 6650W PV on 5kW and 13.3kW on 10kW.

But when battery connected:



GoodWe Energy Storage Product Statement

Dear Australian Customers,

Please refer to the below statement in regards to the maximum DC input power of two models of GoodWe energy storage products.

- 1 The maximum DC input power of GW5048D-ES is 8.5kW
- 2 The maximum DC input power of GW5048-EM is 7.5kW

Please notice:

- 1) GW5048D-ES firmware should be at least version 16 to support the 8.5kW maximum DC

Inbuilt DC-PV2 isolator

GOODWE SOLAR ACADEMY



DECLARATION LETTER

We hereby declare that GoodWe inverters listed below have built-in DC disconnect in compliance with the requirements specified in AS/NZS5033:2104 Amd 1+Amd 2.

DNS Series	GW3000D-NS, GW3600D-NS, GW4200D-NS GW5000D-NS, GW6000D-NS
FH Series	GW3600-EH, GW5000-EH, GW6000-EH
MS Series	GW5000-MS, GW6000-MS, GW7000-MS, GW8500-MS, GW9000-MS, GW10K-MS
SMT Series	GW25K-MT, GW29.9K-MT, GW36K-MT



Battery side: Compatible Batteries

LV



B-Box



RESU 48V



SMILE 5 BAT



PYLONTECH



Pylontech US



Dyness B4850

HV



B-Box HV



Powercube H1(SC1000)

Battery Capacity in Technical Part

For LV battery

- such as BYD, LG – No battery capacity limit
- Conditions may requested from battery suppliers

For HV BYD battery

- based on the inverter battery voltage range plus battery output voltage

Inverter		HVS 5.1	HVS 7.7	HVS 10.2	HVS 12.8	HVM 8.3	HVM 11.0	HVM 13.8	HVM 16.6	HVM 19.3	HVM 22.1
Goodwe	ET	✓	✓	✓	✓	✗	✓	✓	✓	✓	✓
	EH	✓	✓	✓	✗	✓	✓	✓	✓	✓	✓

Battery Size Design

- ✓ Study on customer's electricity bill
- ✓ Install home kit or hybrid without battery to monitor consumption
- ✓ Some storage experts presentation or recommended design tools. Such as Glen Morris video on Youtube or the solar plus design software.

Supply period: 21 Feb 2020 to 20 Mar 2020 (29 days)
NMI: 43104532779
Energy Plan: Solar Savers

Meter no.	Read type	Start reference ¹	End reference ¹	kWh
700383176	Actual	4,193	4,441	247.8
700414991	Actual	559	1,018	459.486
700414991	Actual	8,241	8,505	263.926

¹These reference reads are a guide only and may not reflect the total energy consumption for this billing period. Your next meter read is due between **19 Feb 19** and **25 Feb 19**. Please ensure easy access to your meter on these days.

How we've worked out your bill.

Previous balance and payments.		Total
Previous balance	\$106.47	
9 Mar 20 payment	\$106.47cr	
Balance brought forward		\$0.00

Price	Amount	
579	\$68.07	
97	\$29.66	
.82	\$23.78	
.06	\$1.74	
		+ \$123.25
0.21	\$96.49cr	
		- \$96.49cr

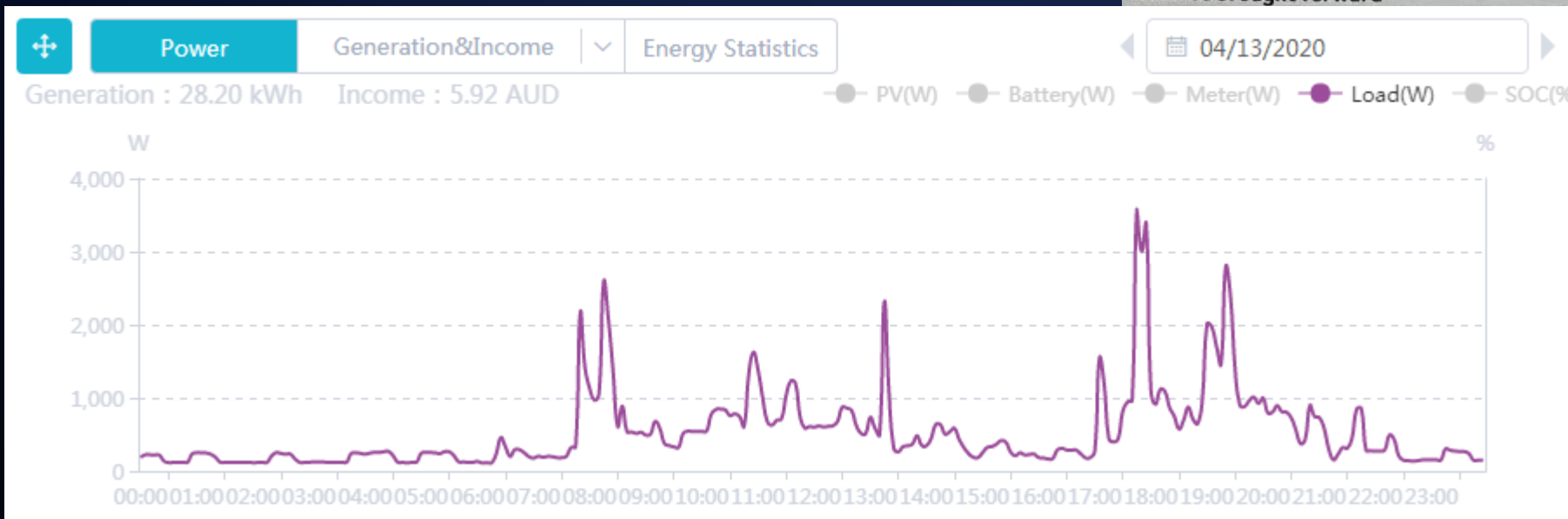

According to our statistic, the average battery size in AU now is 10kWh – 13.8kWh

Case Study

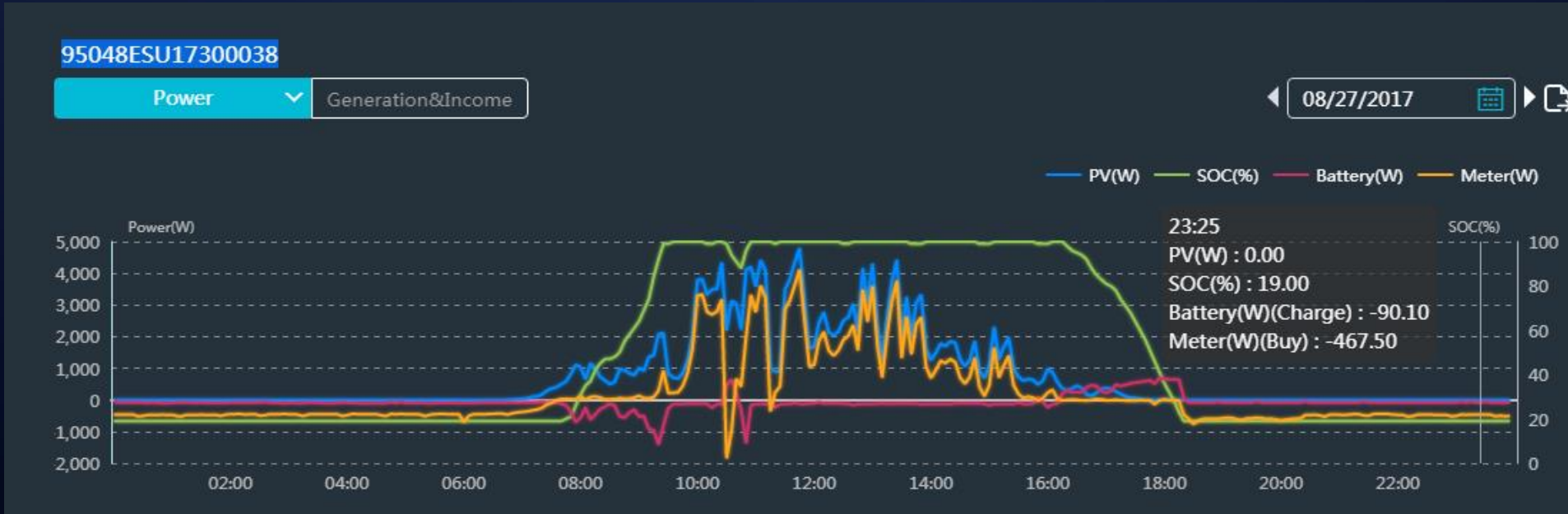

One 2.5kWh BYD battery only run for 1-2hours discharge

Good Design

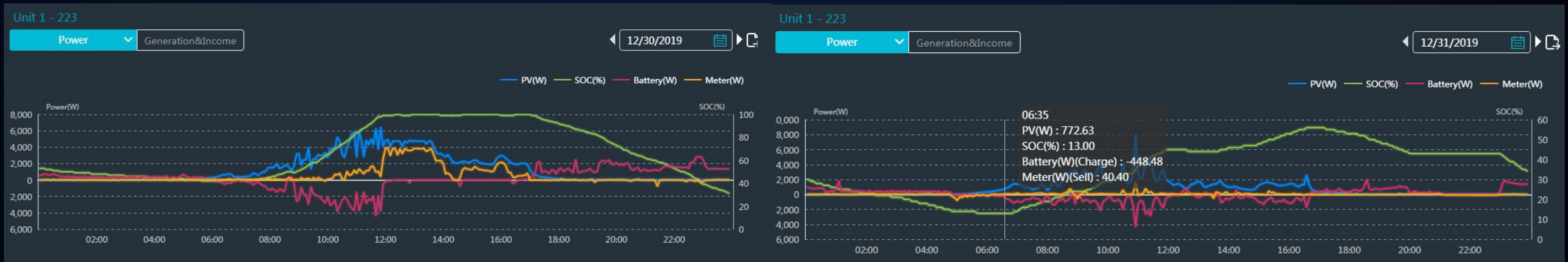

AC side: Back up Size design

Declaration For Back-Up Loads

GoodWe ES inverter is able to supply a continuous 4600VA output or max 6900VA in less than 10 seconds on Back-Up side to support backup loads. And the inverter has self-protection derating at high ambient temperature.

Accepted loads as below:

- Inductive Load: Max 1.5KVA for single inductive load, max 2.5KVA for total inductive load power
- Capacitive load: Total capacitive load (like computer, switch power etc.) power < 3.0KVA

Note:

For convenient maintenance, please install a SP3T switch on back-up and on-grid side. Then it is adjustable to support load by back-up or by grid or default settings.

For a convenient switch could be installed on the On-Grid side to support load, leave it there.

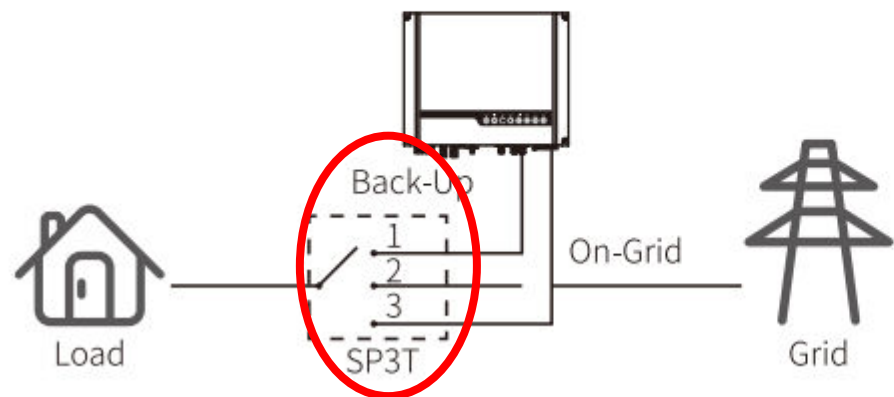

1. Back-up load is supplied from back-up side.
2. Back-up load is isolated.
3. Back-up load is supplied from grid side.

Case Study

Chris Taylors

Pbackup1

Generation&Income

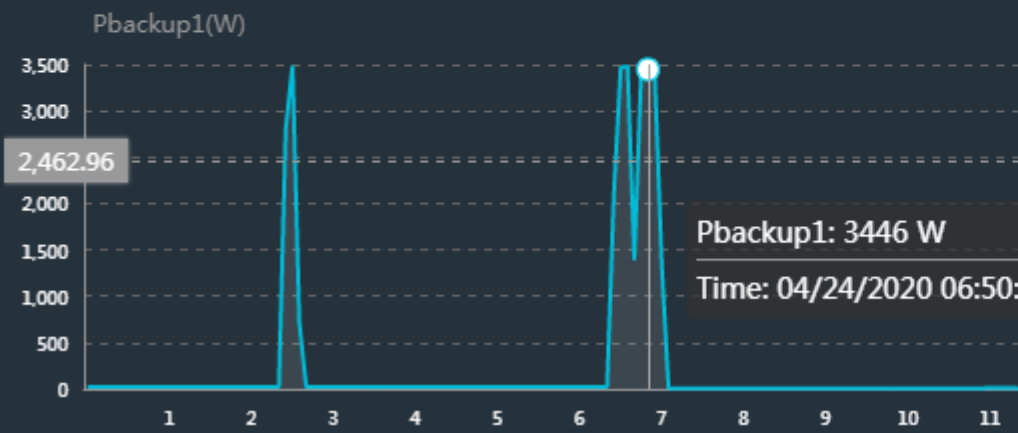

**ET10kW, back up 3.3kW per phase.
Overloading happened on Phase 1.**

LocalTime	ID	InventerSN	ACApp	BackUpPload_R	BackUp	BackU
2020/4/24 6:52:54	0eb5521e-	9010KETL195W0032	0	3452	0.8	5
2020/4/24 6:47:53	b0e830cd-	9010KETL195W0032	0	3457	0.8	5
2020/4/24 6:43:52	842a314a-	9010KETL195W0032	0	3457	0.8	4
2020/4/24 6:36:43	d4884757-	9010KETL195W0032	0	3475	0.8	4
2020/4/24 6:35:43	ea77df0a-	9010KETL195W0032	0	3481	0.8	5
2020/4/24 6:34:43	fb12e330-	9010KETL195W0032	0	3476	0.8	4
2020/4/24 6:33:43	a3d4aa35-	9010KETL195W0032	0	3455	0.8	4
2020/4/24 6:32:43	3ccab9b1-	9010KETL195W0032	0	3465	0.8	5
2020/4/24 6:31:43	c55331b9-	9010KETL195W0032	0	3468	0.8	4
2020/4/24 6:30:42	3c269969-	9010KETL195W0032	0	3478	0.8	4
2020/4/24 6:29:42	d26d33a6-	9010KETL195W0032	0	3483	0.8	4
2020/4/24 6:28:42	fcec4a01-	9010KETL195W0032	0	3495	0.7	5
2020/4/24 6:27:42	72b556b2-	9010KETL195W0032	0	3485	0.7	4
2020/4/24 2:35:12	ae5a13f3-	9010KETL195W0032	0	3488	0.2	4
2020/4/24 2:34:12	c328e719-	9010KETL195W0032	0	3489	0.2	4
2020/4/24 2:33:11	8afcd80f-	9010KETL195W0032	0	3497	0.2	4
2020/4/24 2:32:11	7f73112b-	9010KETL195W0032	0	3488	0.2	4
2020/4/24 2:31:11	7c3b31b6-	9010KETL195W0032	0	3490	0.2	5
2020/4/24 2:30:11	4e9975be-	9010KETL195W0032	0	3482	0.2	5
2020/4/24 2:29:11	3494b03f-	9010KETL195W0032	0	3506	0.2	5
2020/4/24 2:28:11	1c304881-	9010KETL195W0032	0	3471	0.2	4
2020/4/24 2:27:11	4165f1ac-	9010KETL195W0032	0	3496	0.2	4

Cabling & Breaker size

LV Inverter (GW5048D-ES, 5048-EM and GW5000S-BP)

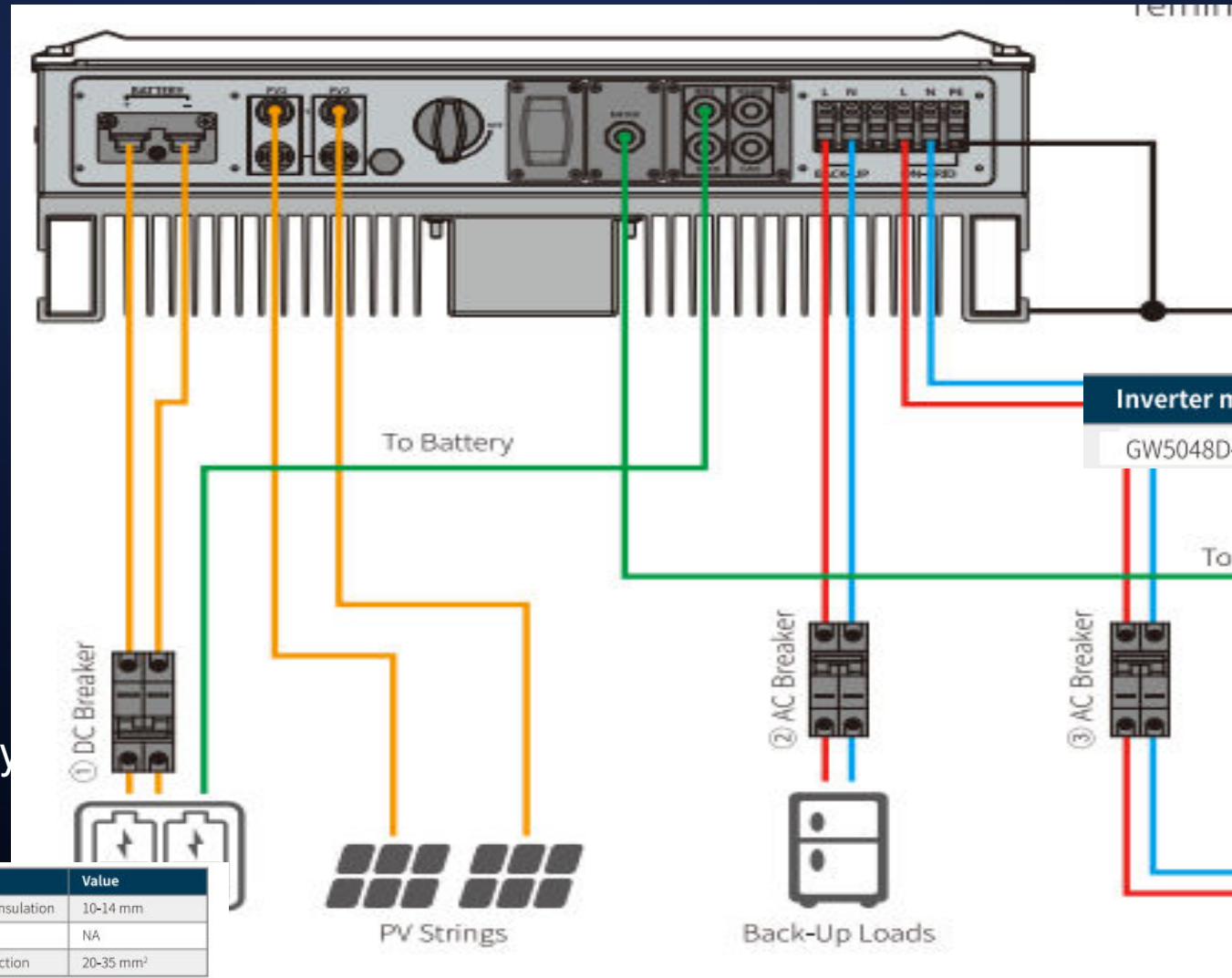

Cable and breaker selection referring to practical condition

125A External DC breaker (request referring to battery supplier)



Grade	Description	Value
A	Outside Diameter Insulation	10-14 mm
B	Isolation Section	NA
C	Conductor Core Section	20-35 mm ²

Cabling & Breaker size

HV Inverter (GW5000EH and GW5000ET)

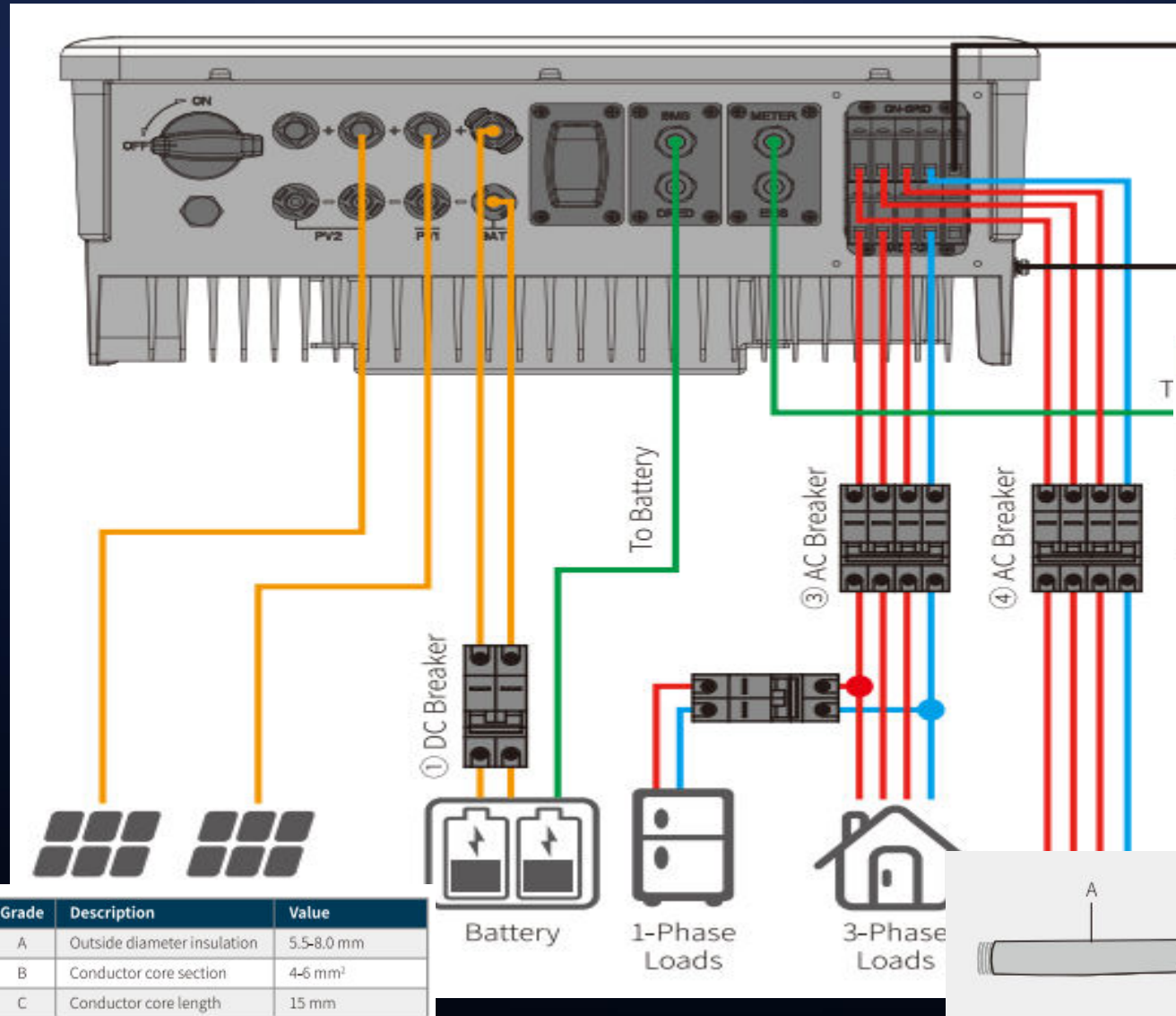

Inverter model	AC breaker specification
GW5K/GW5KL-ET	25A / 400V (e.g. DZ47-60 C25)
GW6K5/GW6KL-ET	25A / 400V (e.g. DZ47-60 C25)
GW8K/GW8KL-ET	32A / 400V (e.g. DZ47-60 C32)
GW10K/GW10KL-ET	32A / 400V (e.g. DZ47-60 C32)



Figure 2.4.2-1

Grade	Description	Value
A	Outside diameter insulation	5.5-8.0 mm
B	Conductor core section	4-6 mm ²
C	Conductor core length	15 mm



Grade	Description	Value
A	Outside diameter	13-18 mm
B	Separated wire length	20-25 mm
C	Conductor wire length	7-9 mm
D	Conductor core section	4-6 mm ²

03

Physical wiring

System Operation (charging in the day)

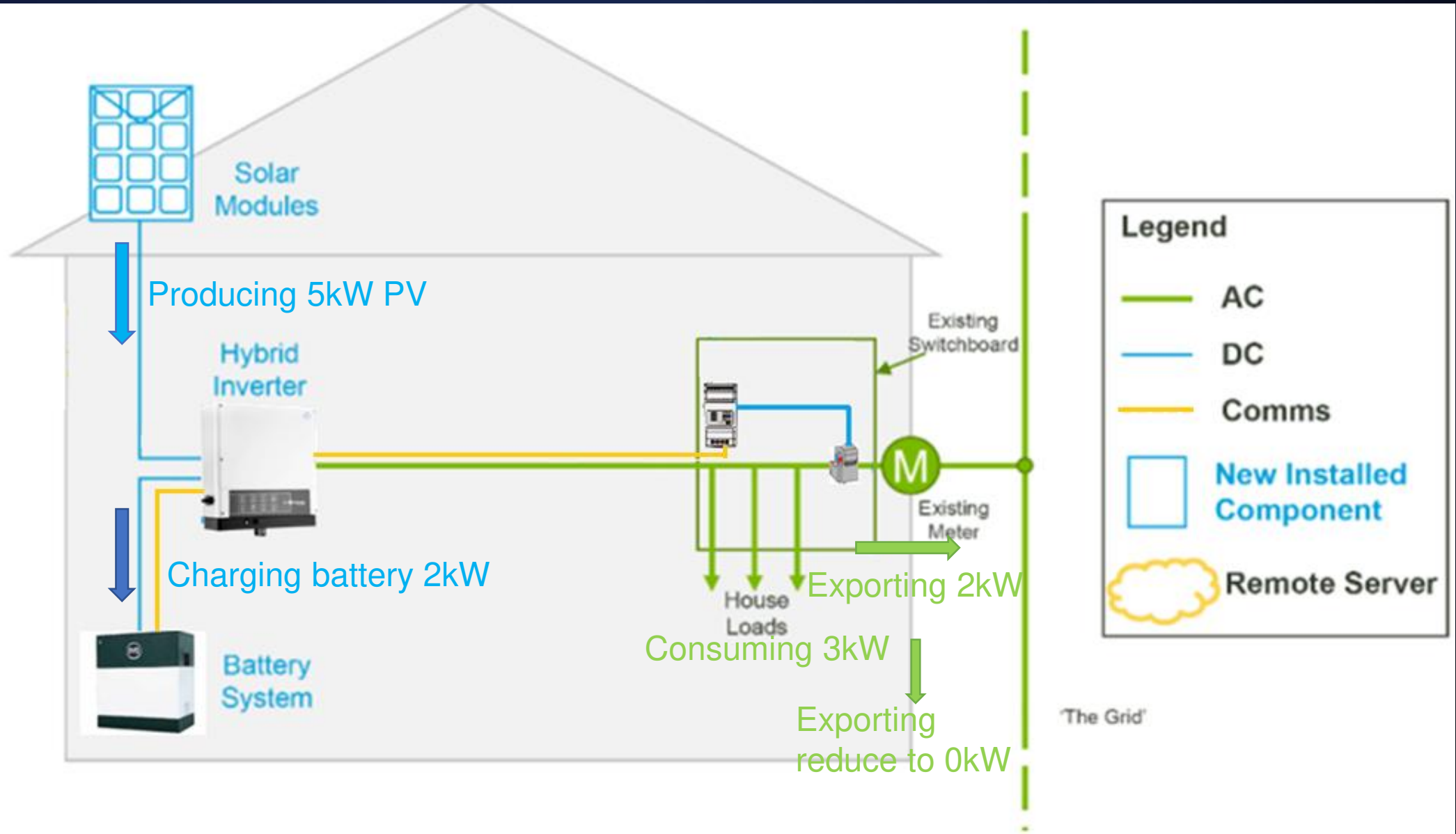

System Operation (discharging at night)

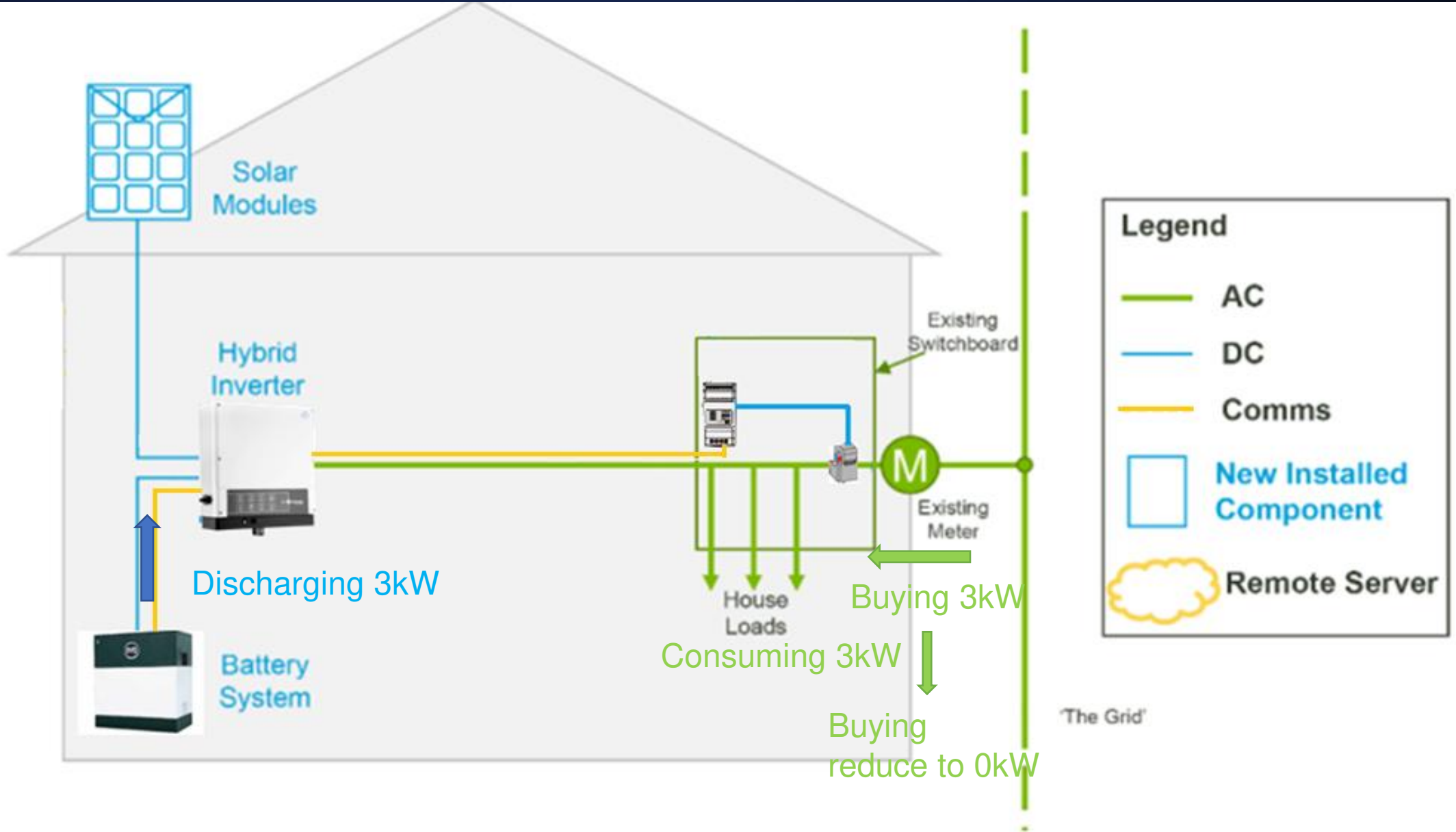

ES, EM, SBP, EH, ET architecture

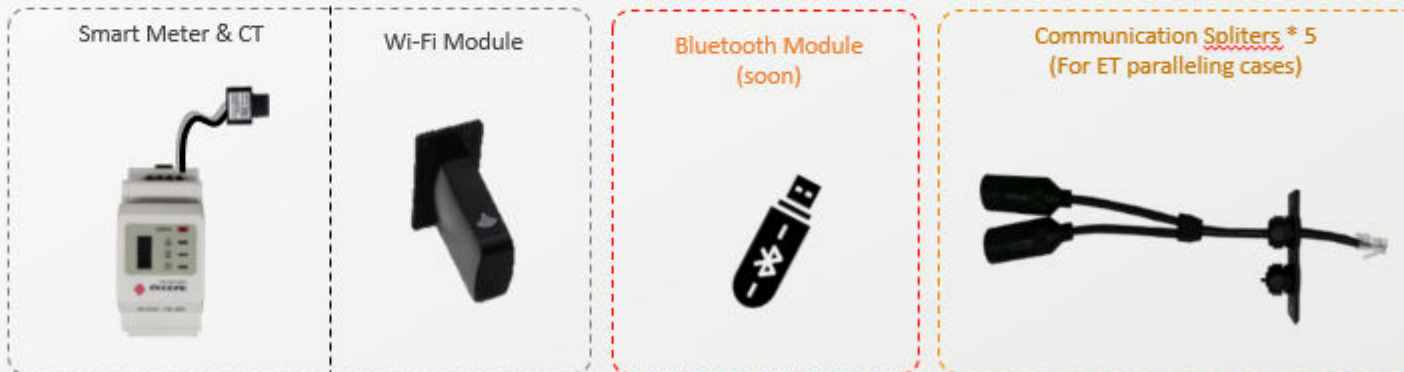
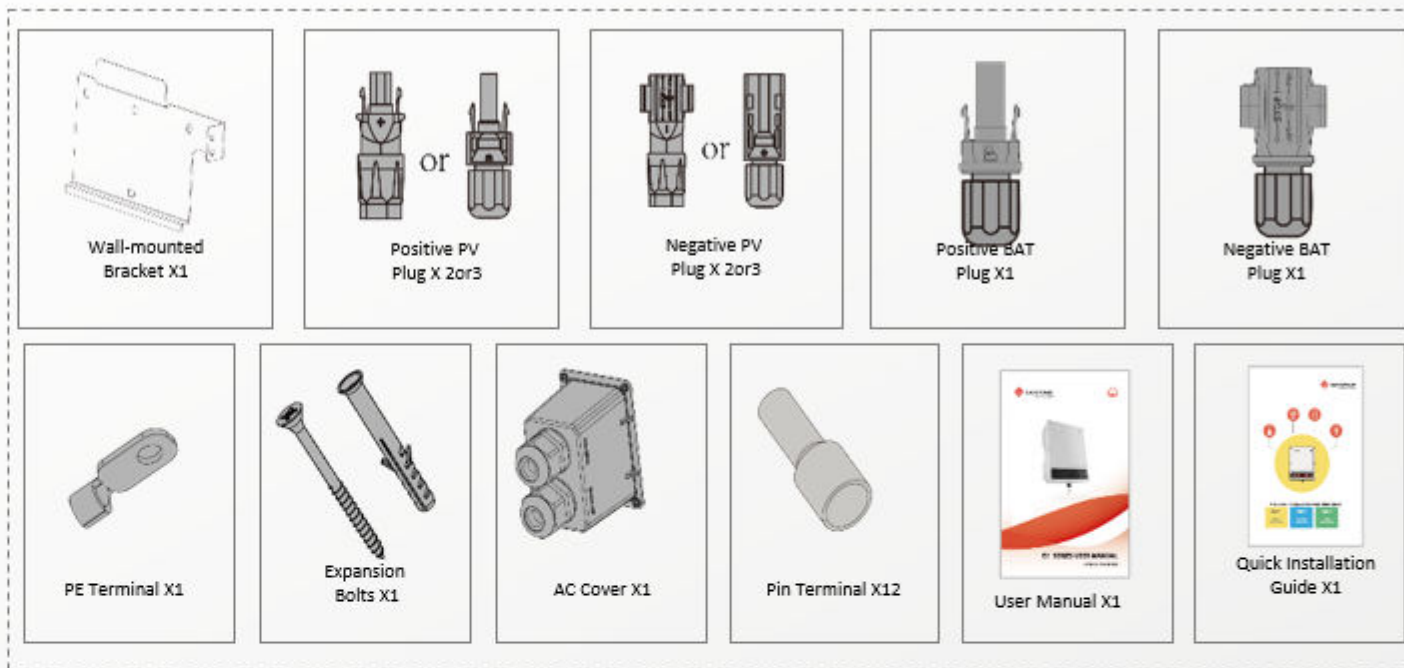
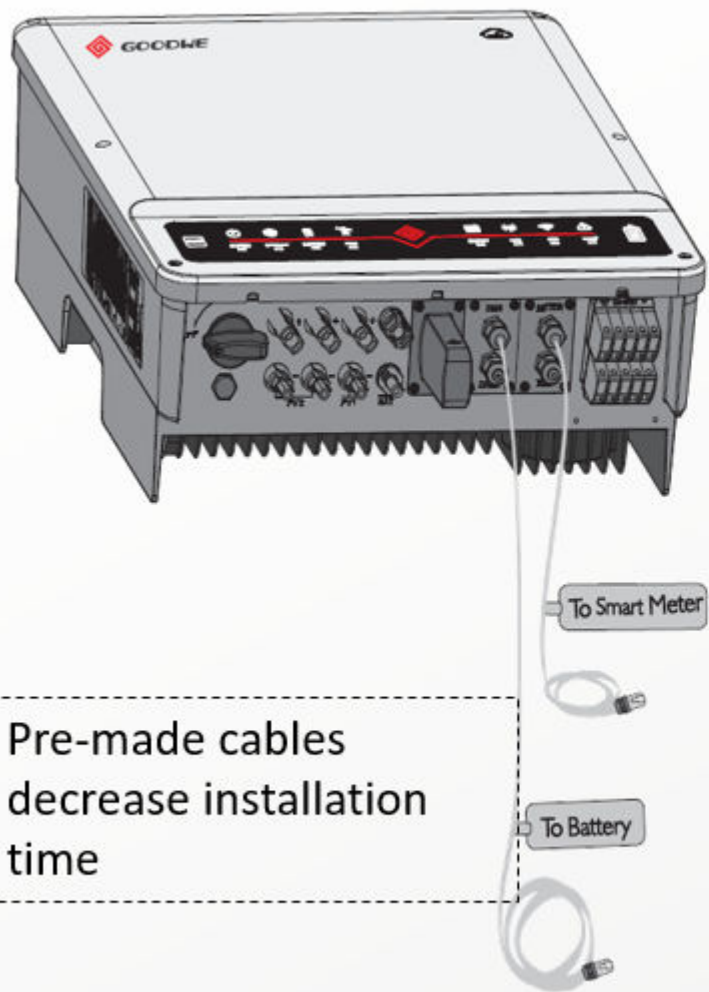

Make data cable properly

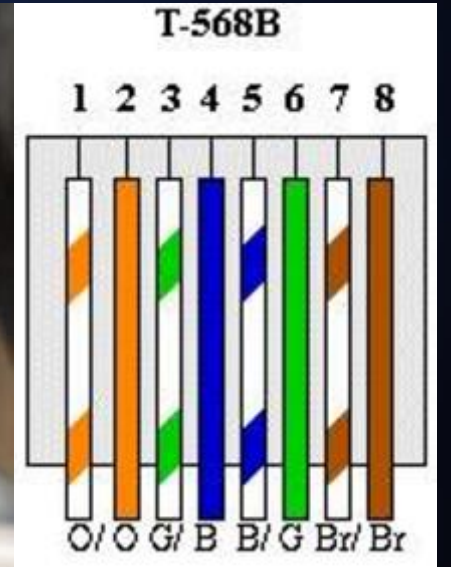
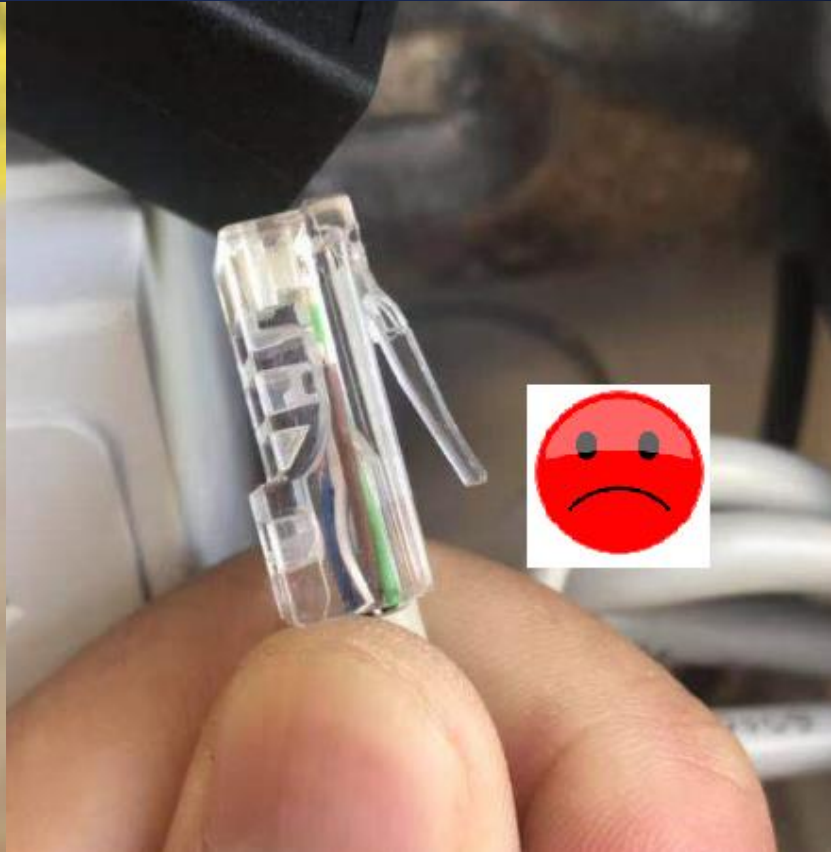
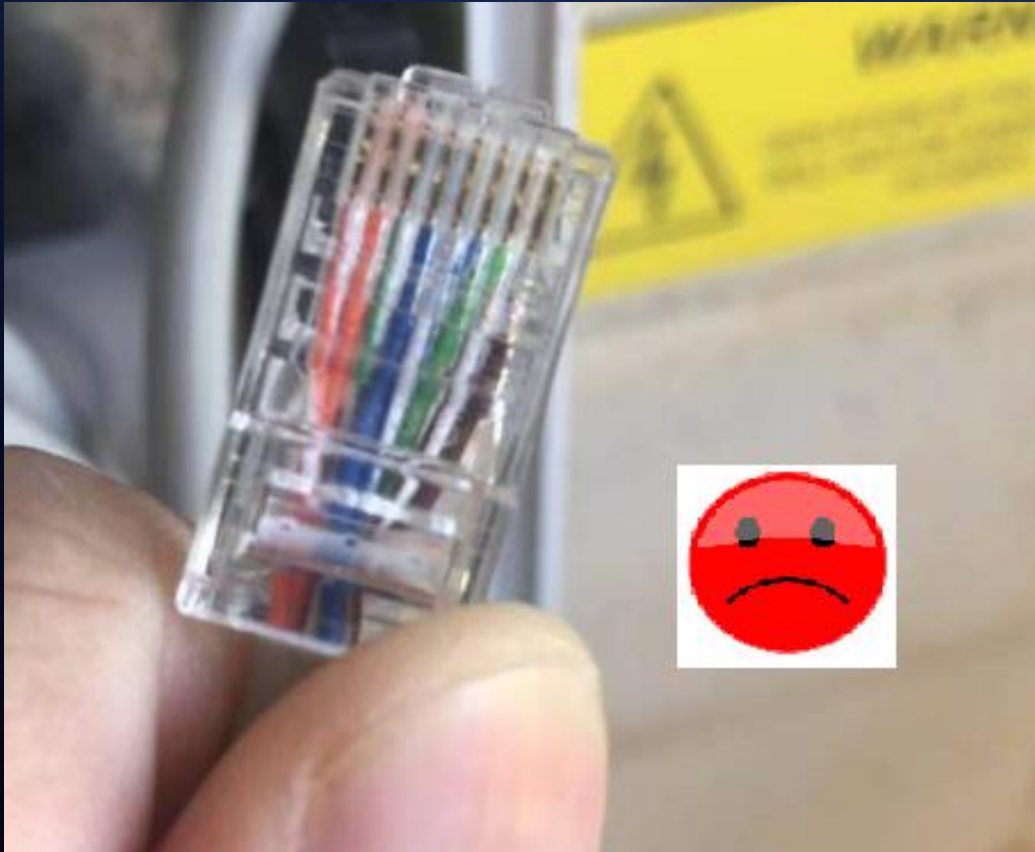

Referring to T568B for remaking the data cable if necessary

Meter&CT Installation

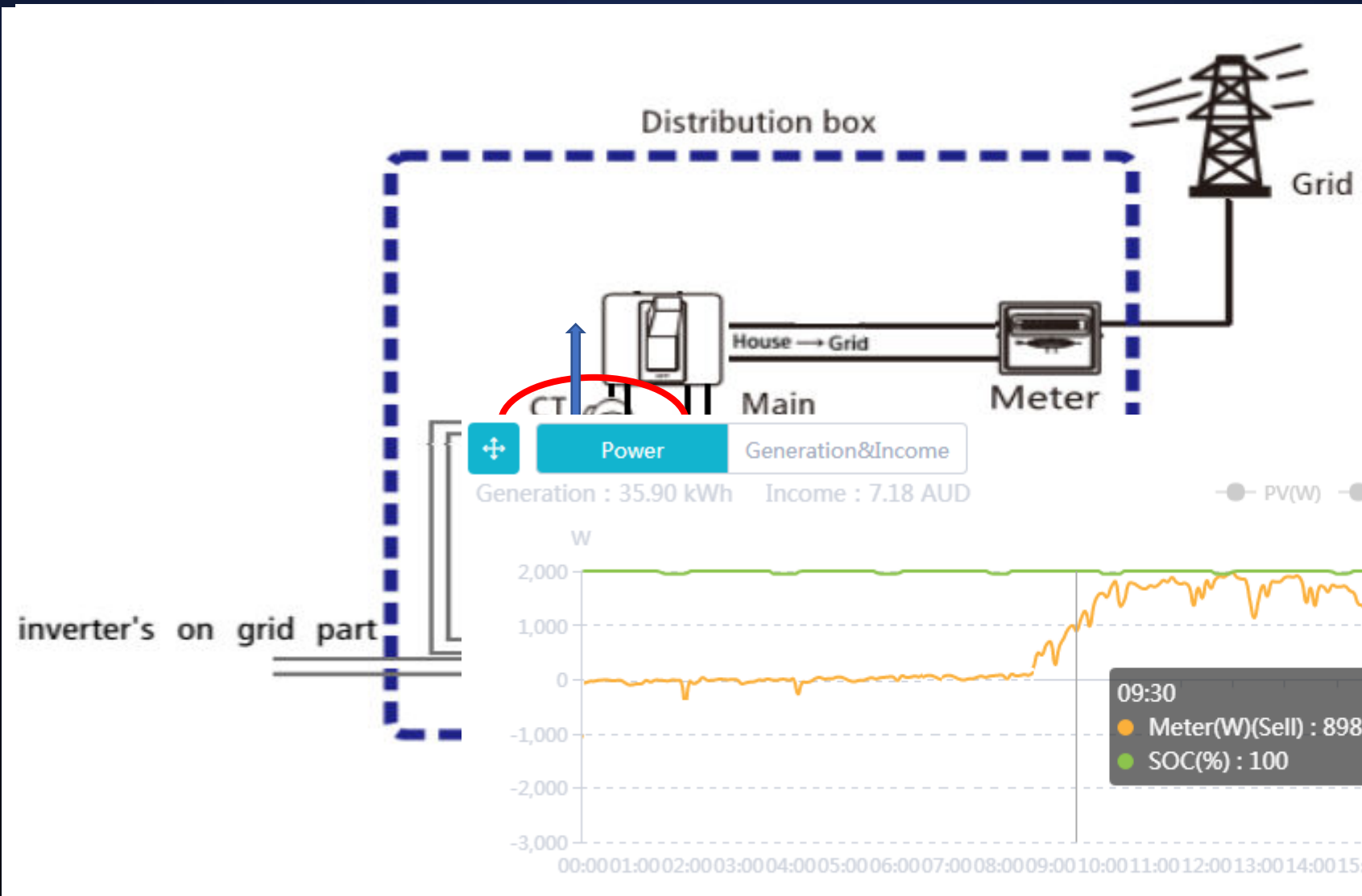

CT be put incorrectly around solar main breaker cable

Battery only charging but no discharging

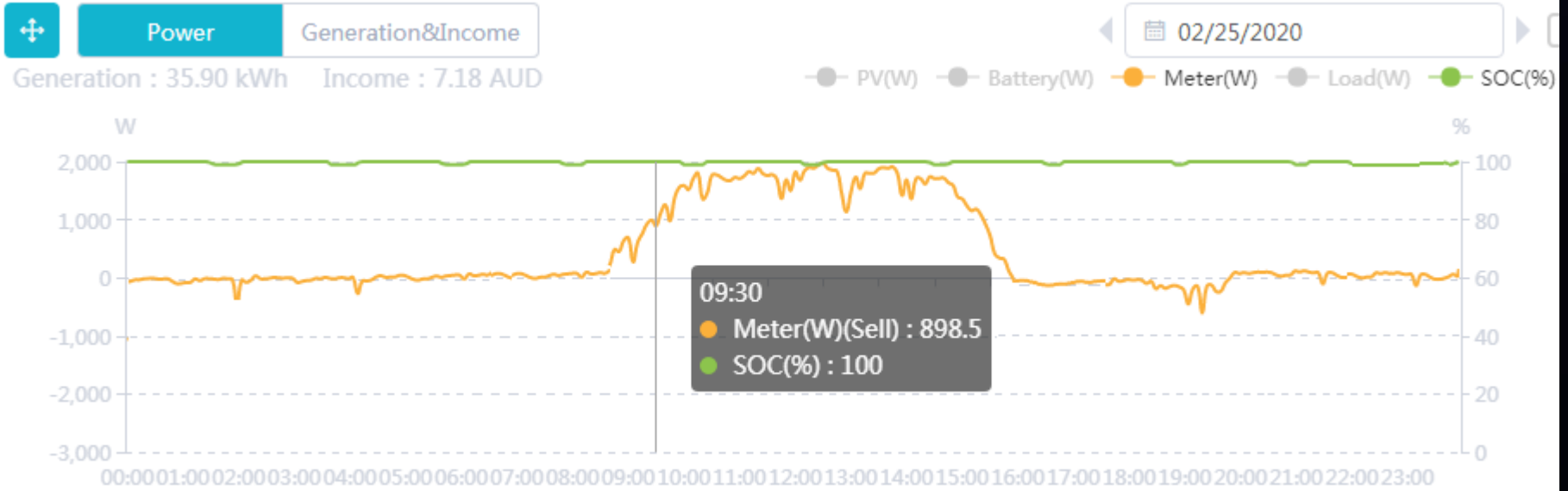

Case study

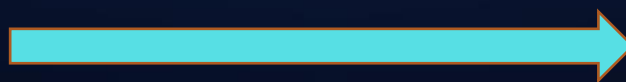
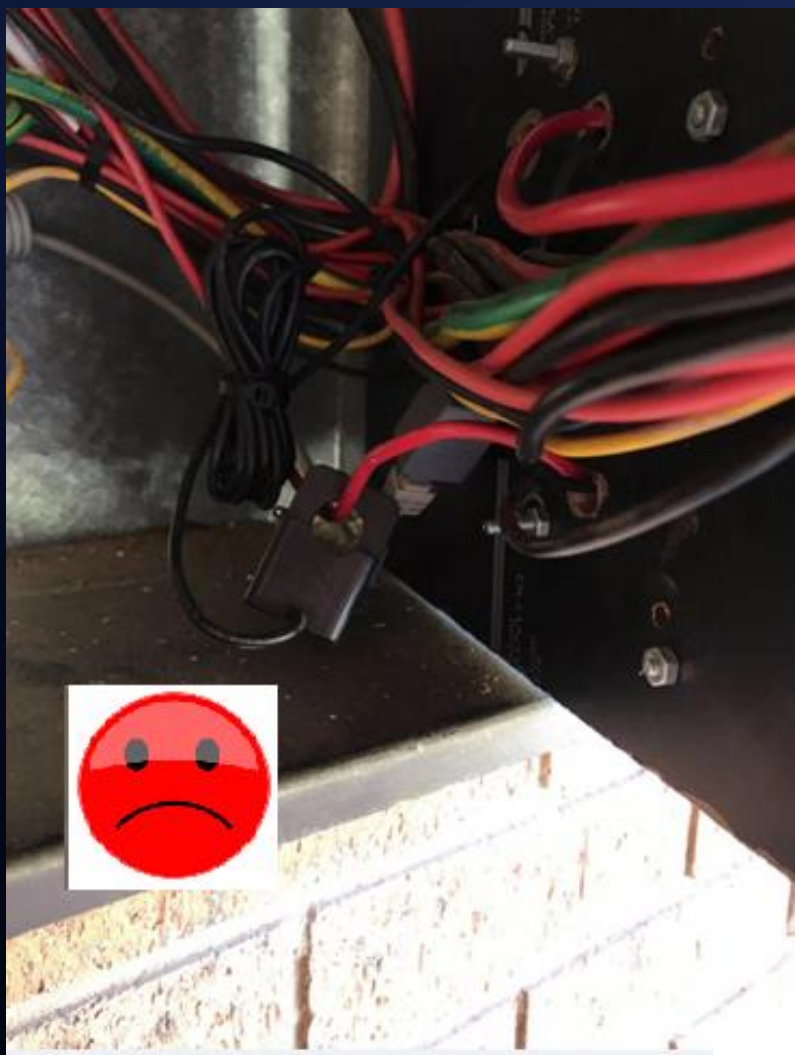

Meter&CT Installation

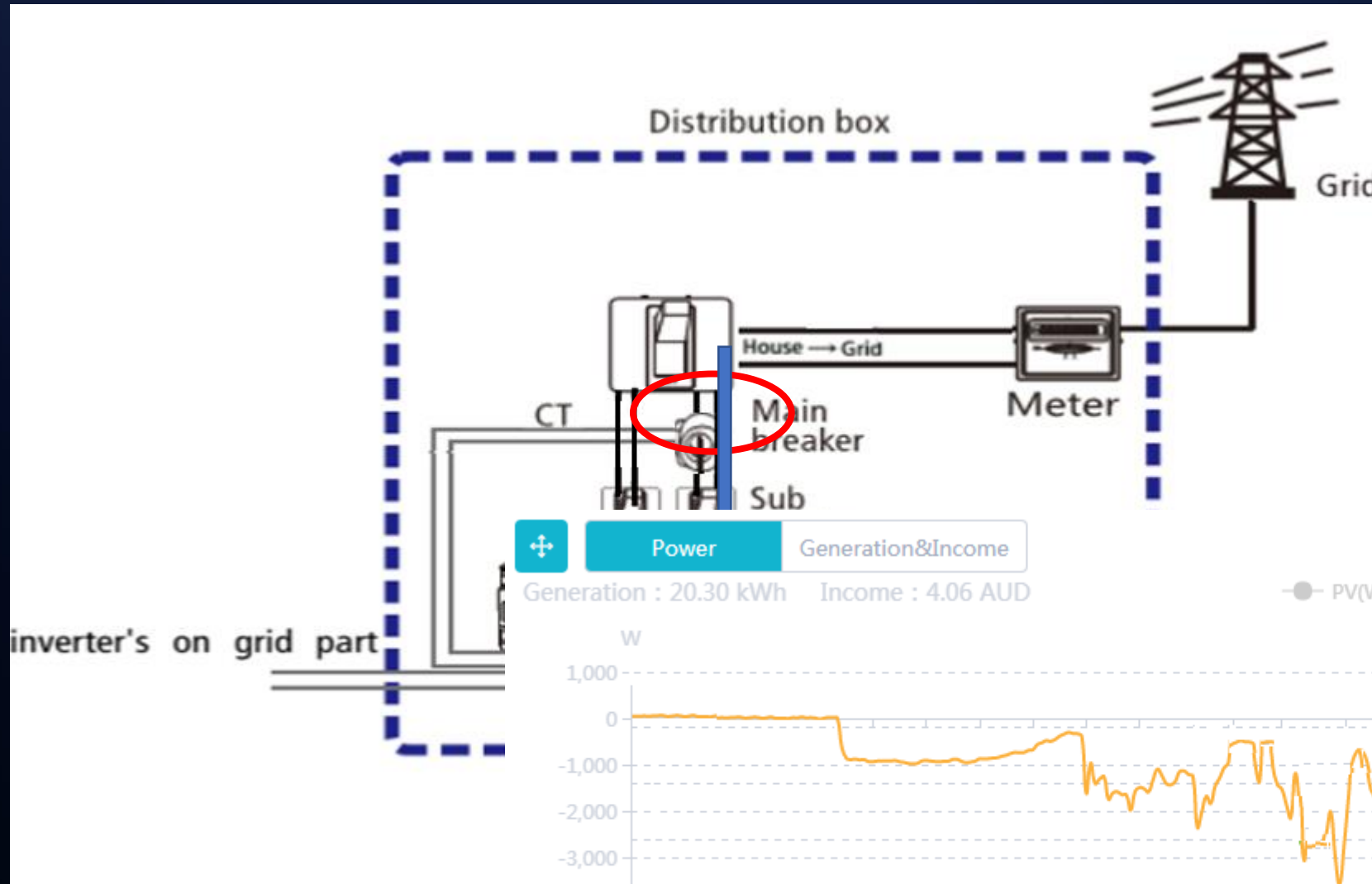

CT be put incorrectly around consumption cable

Battery only discharge but no charging

inverter's on grid part

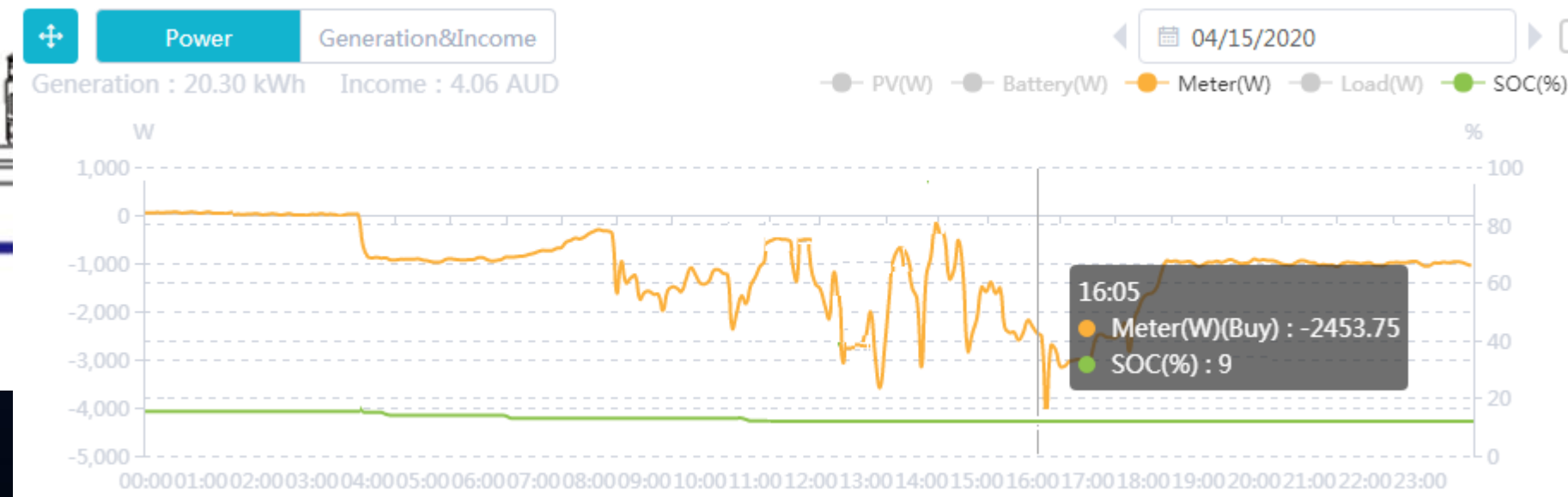

Meter&CT Installation on sign

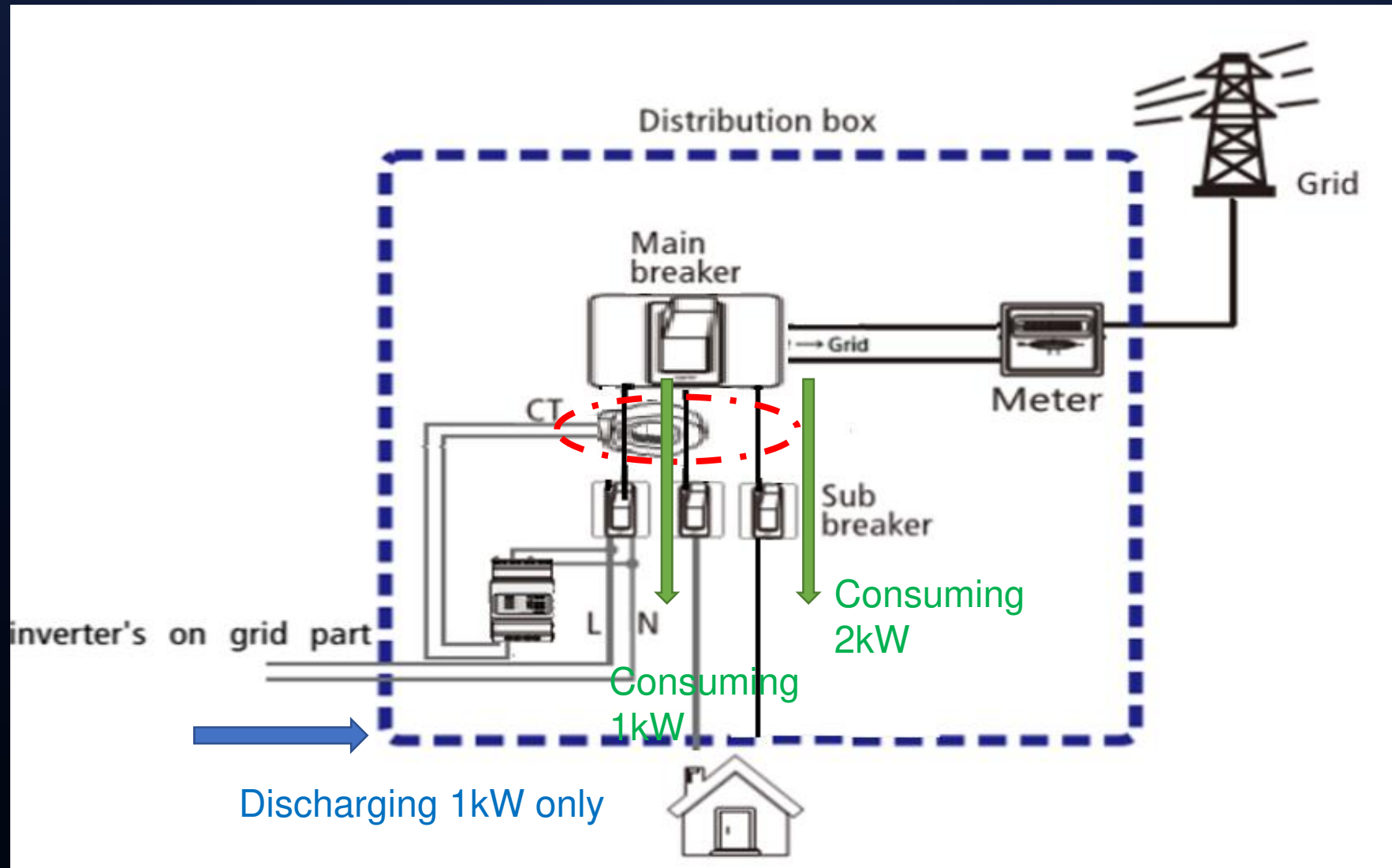

CT be put incorrectly around partially consumption cable

Case study

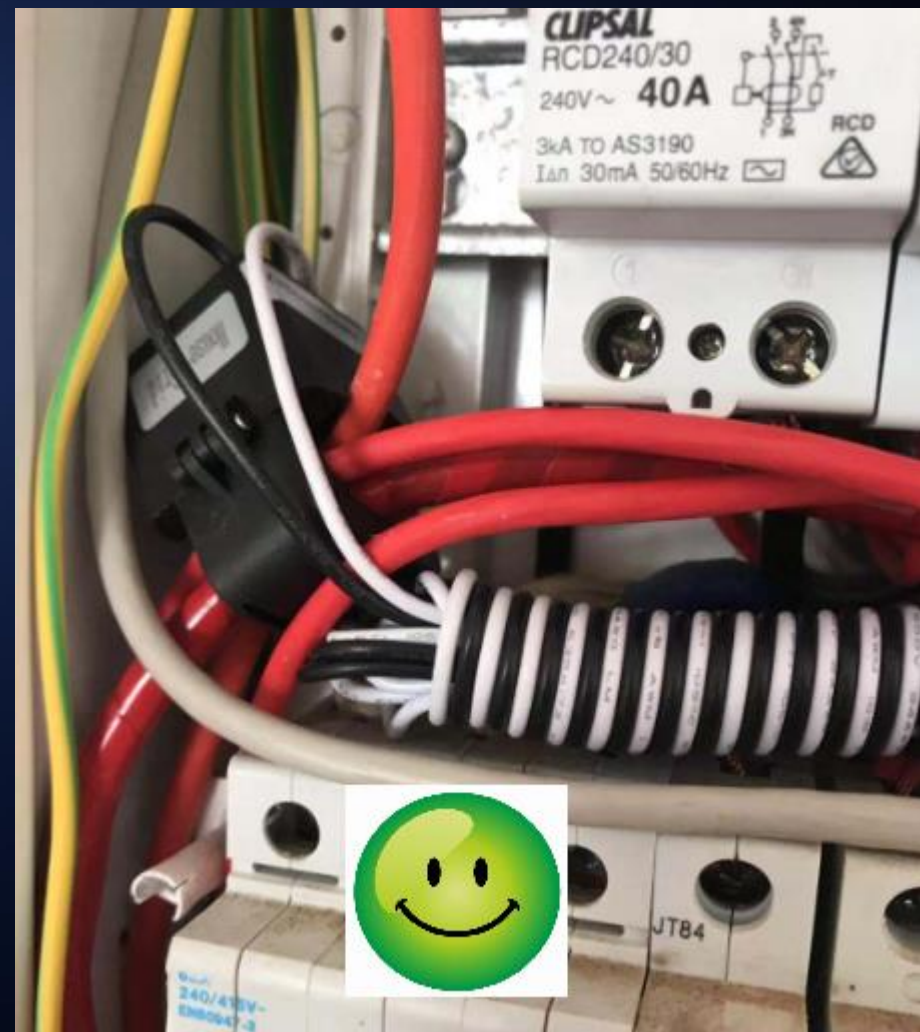
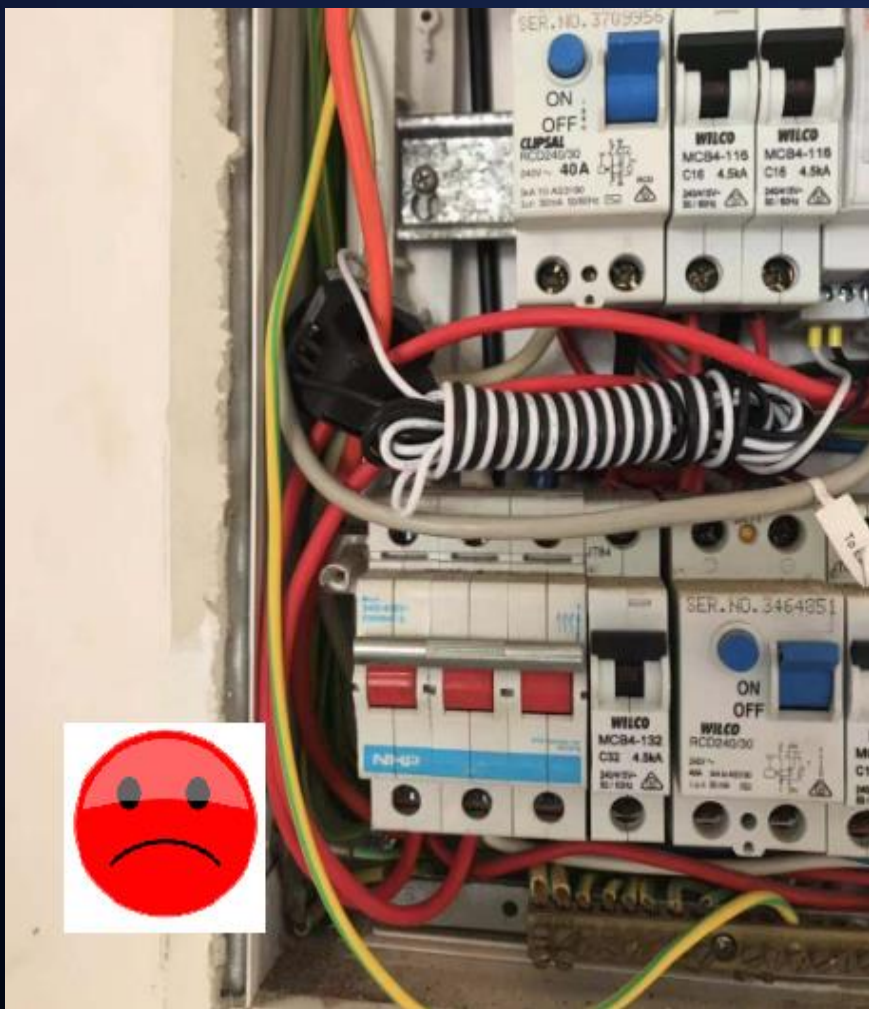

CT direction

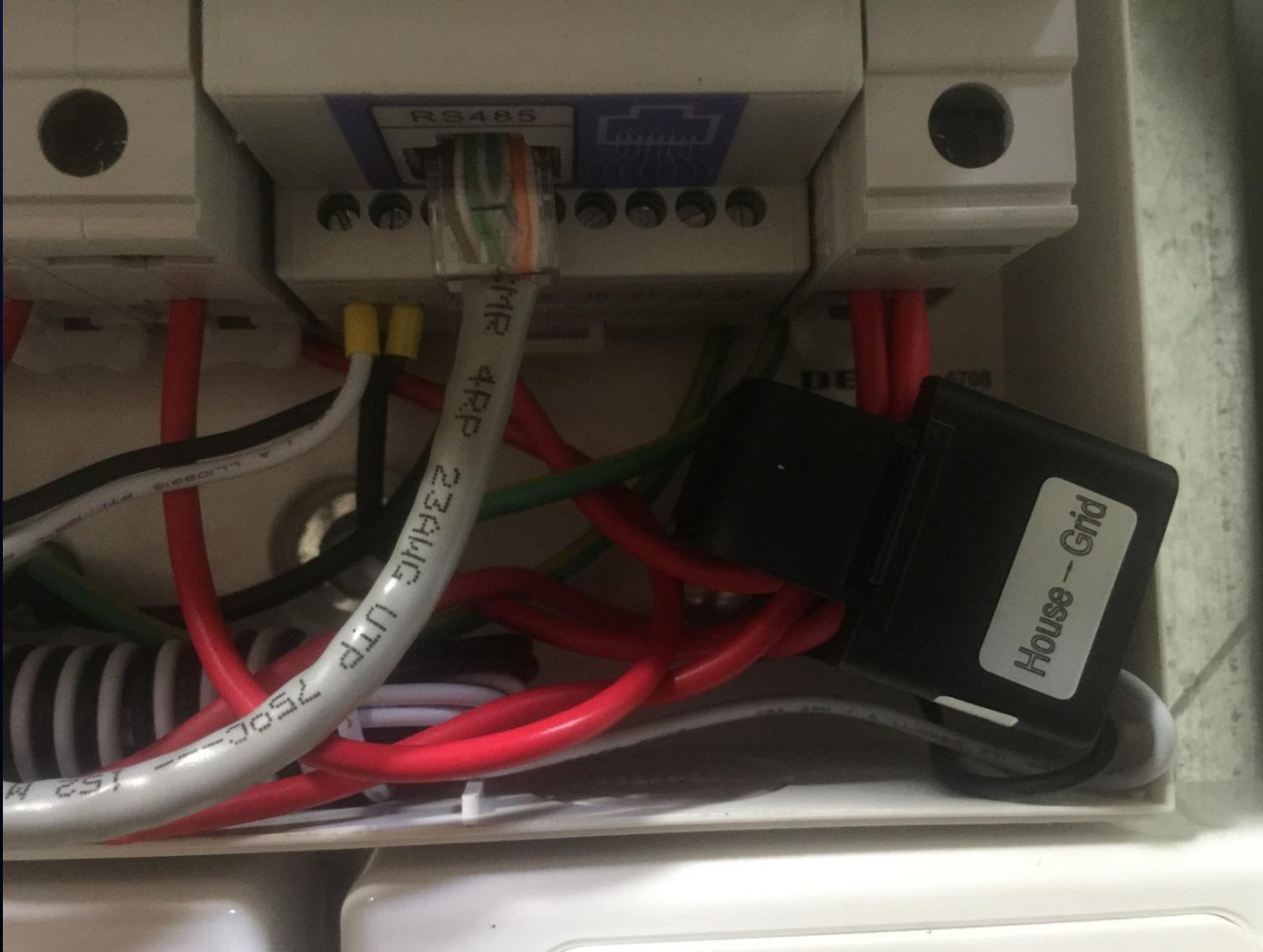

Hints:

- The energy of Solar/Battery as well as the loads must pass through the CT
- CT clamp has its direction. The label on CT indicates the correct orientation. HOUSE indicates load side, GRID indicates line side.
- CT has pre-connected with meter GM1000 or GM3000

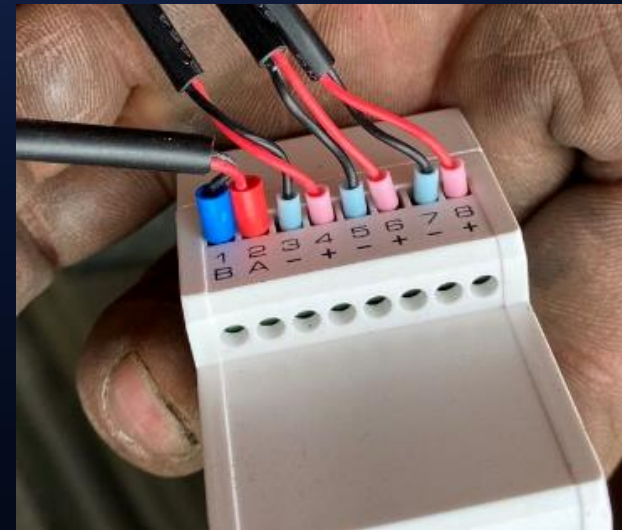

Three Phases House – GM1000

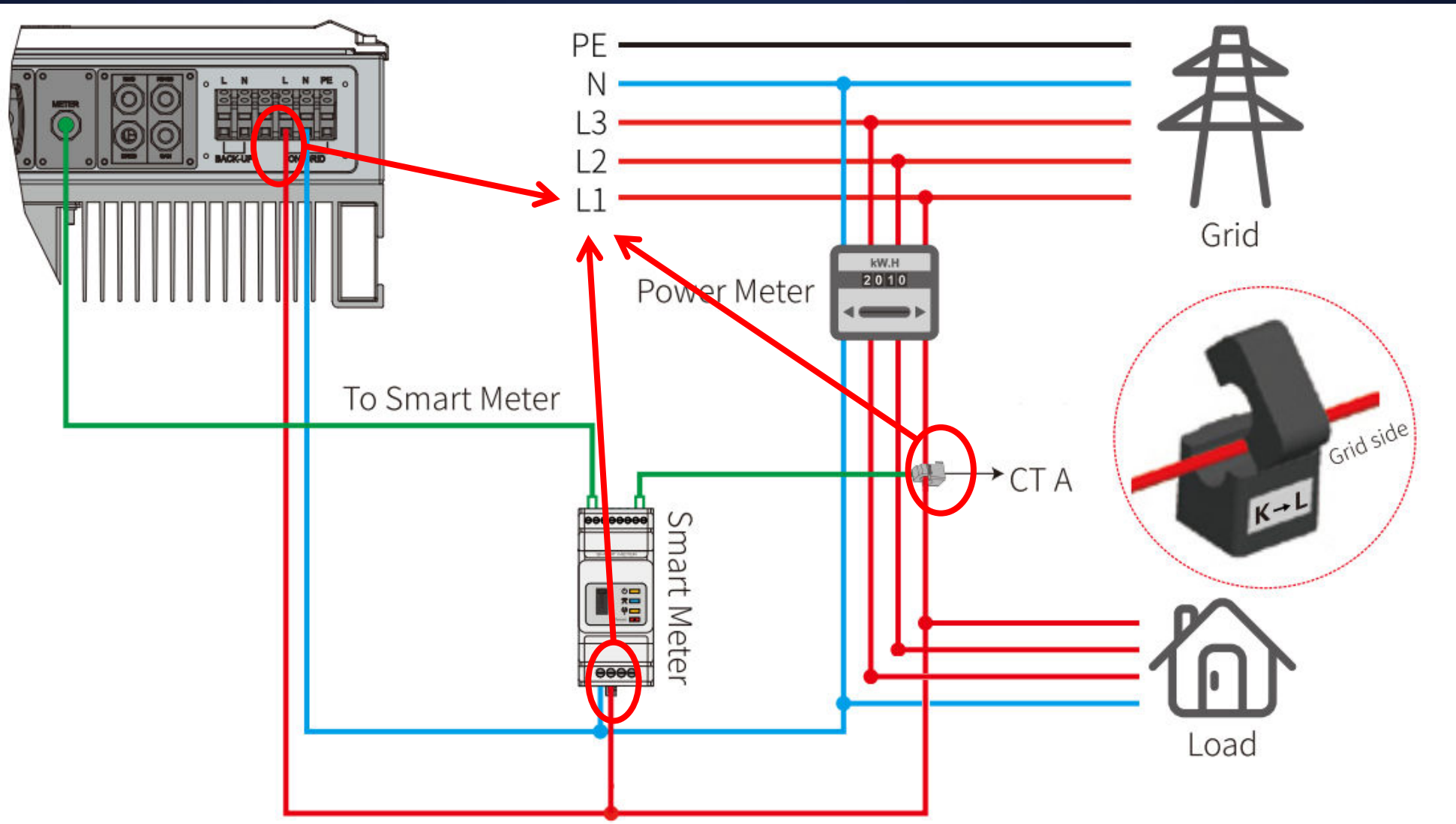

Inverter, Voltage refer on Meter and CT must be from same phase.

Three Phases House – GM3000

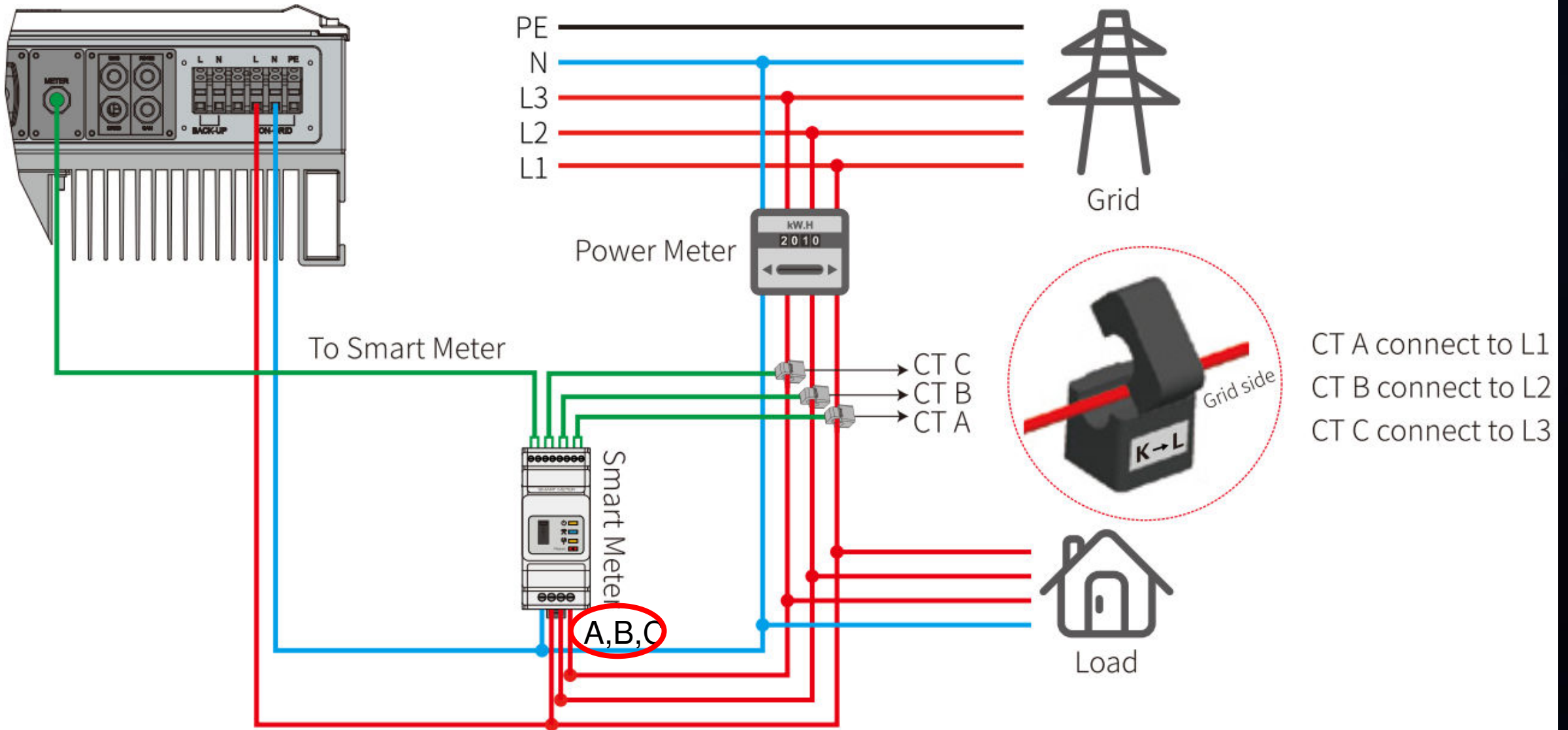

Three Phases House – GM3000 – how it works

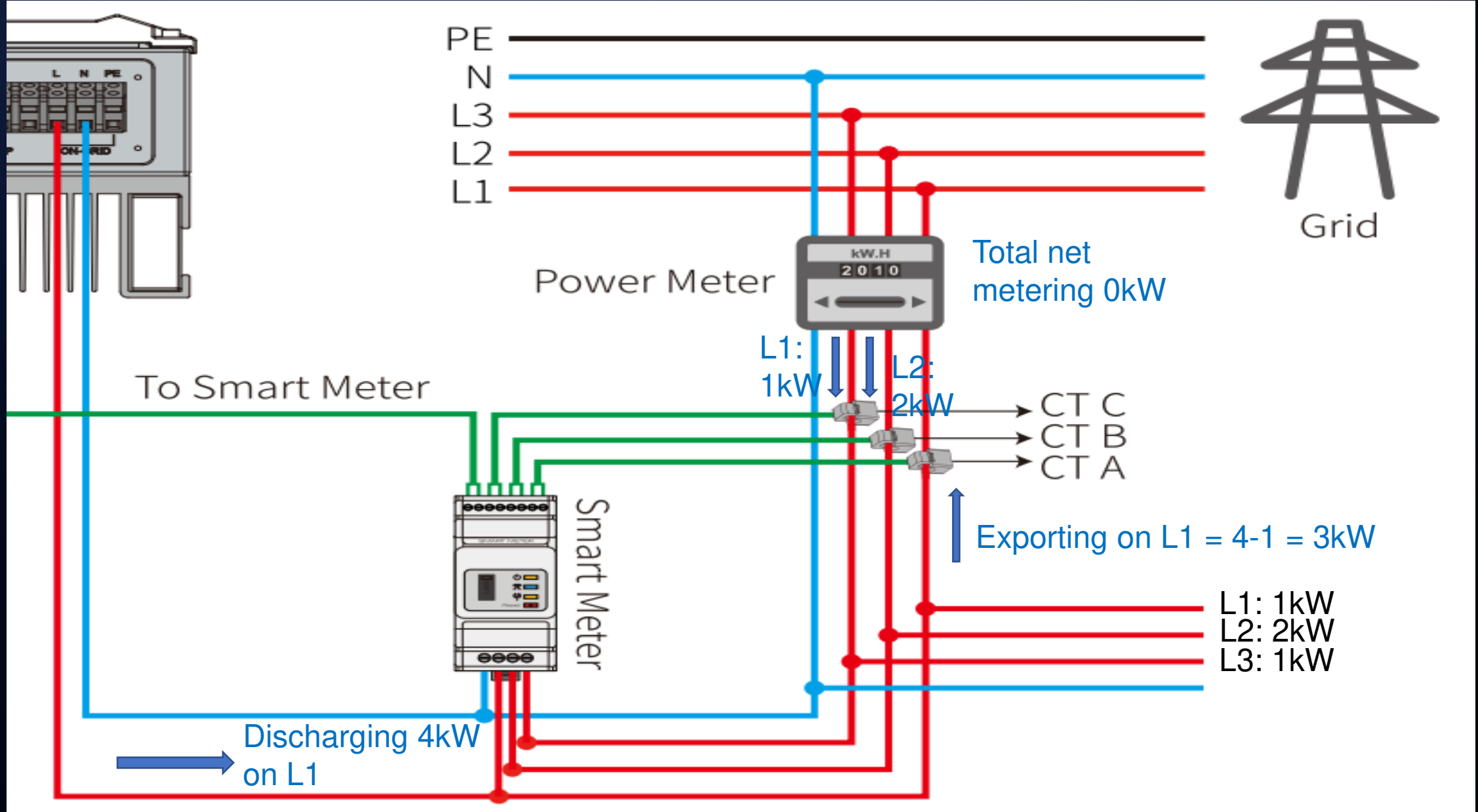

Case study

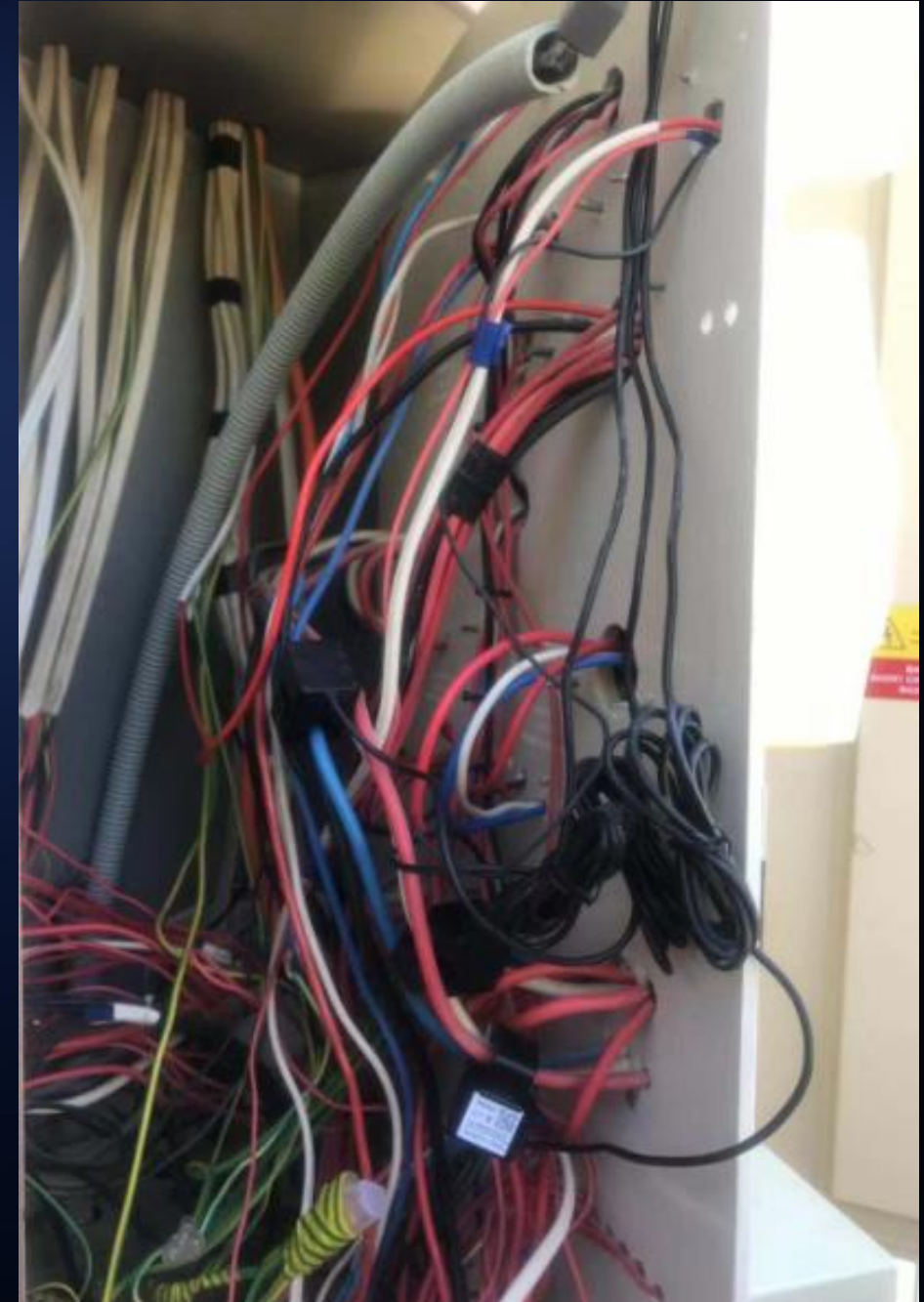

Case study II

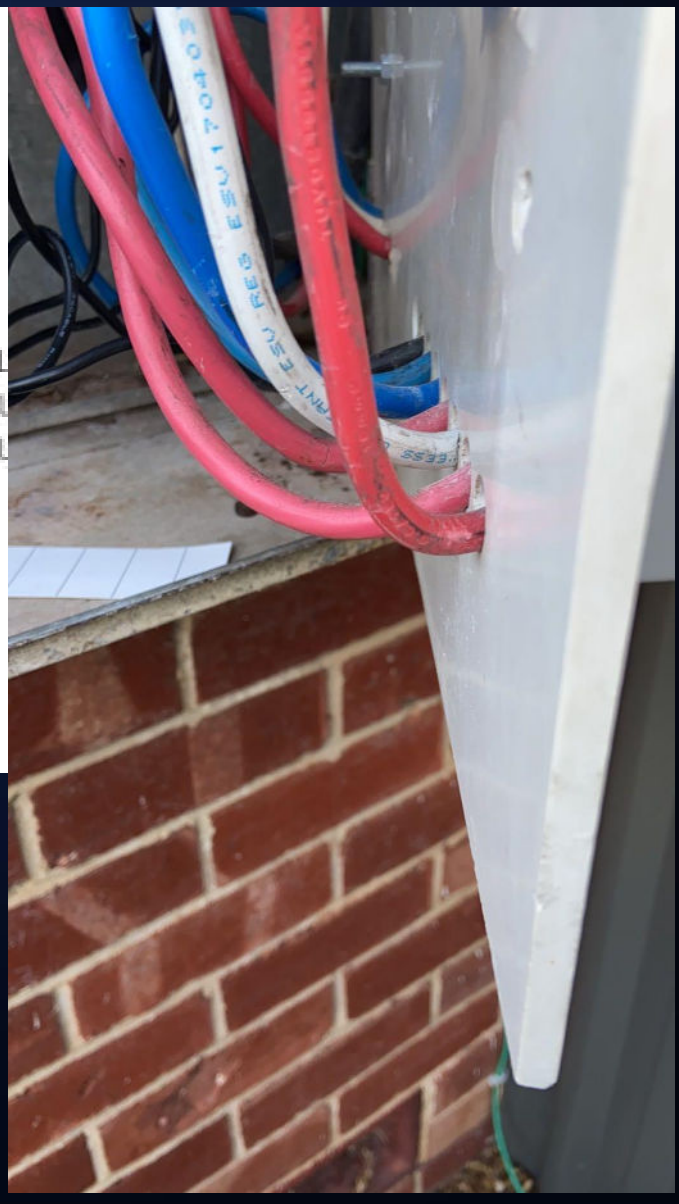
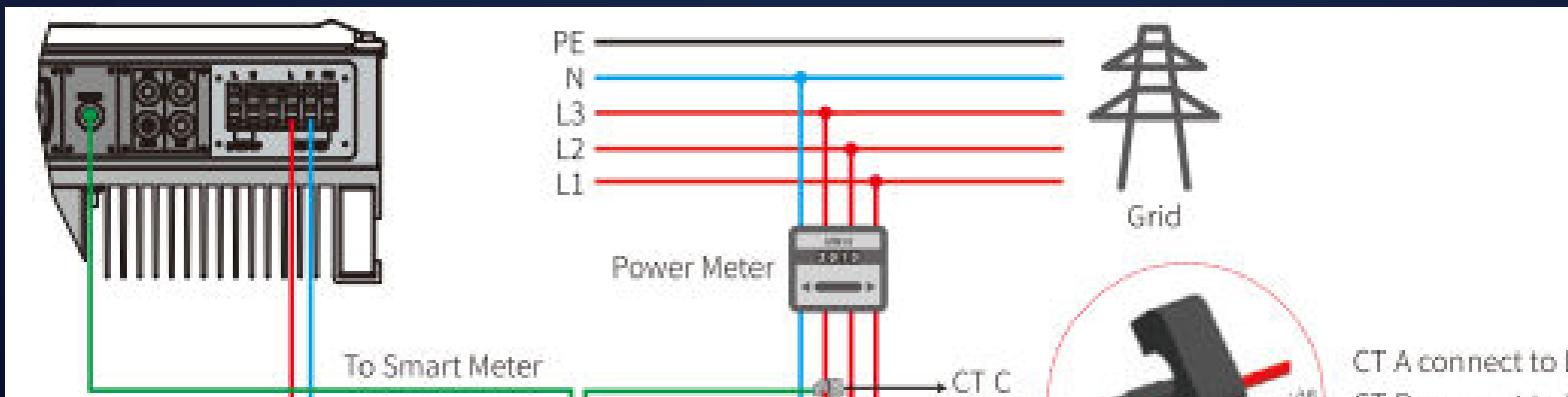

Back Up wiring

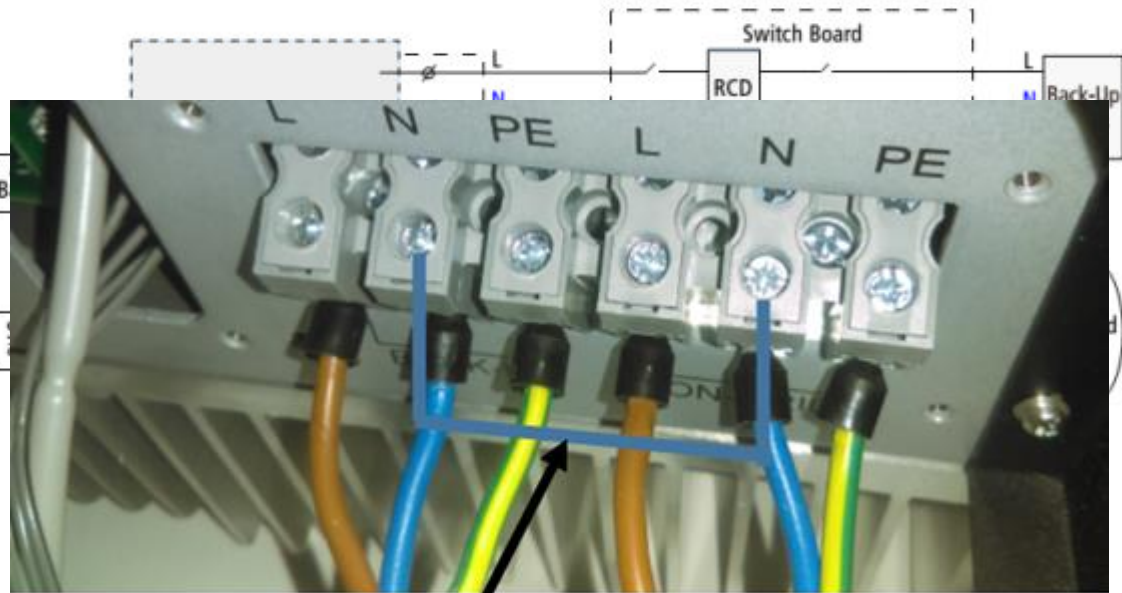

Proposed Neutral link

Hints:

The neutral on back up part and neutral on grid tied part must be jumped together

Hints:

Go to the advanced settings and turn the Back-Up Supply ON.

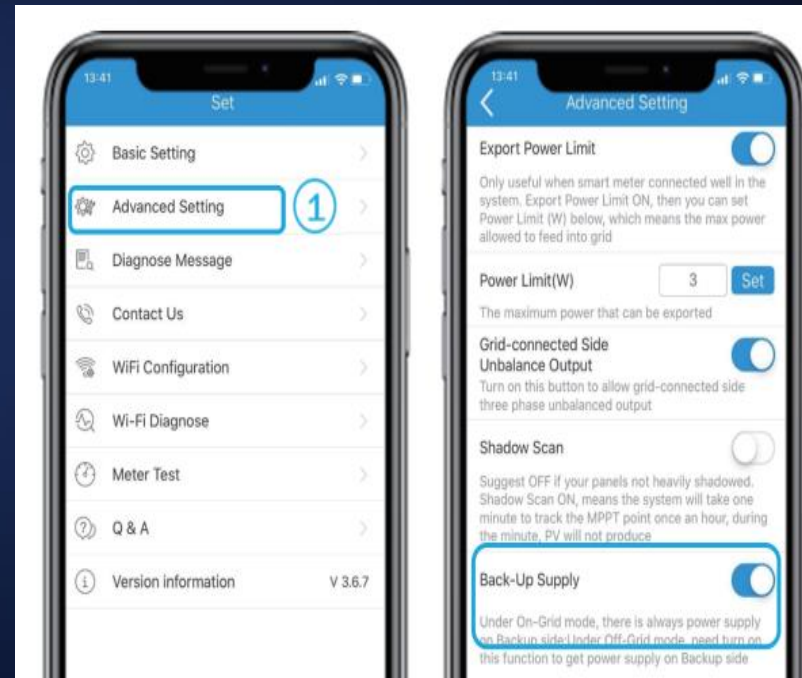

Back Up LED light on inverter will be ON to indicate the function is enable

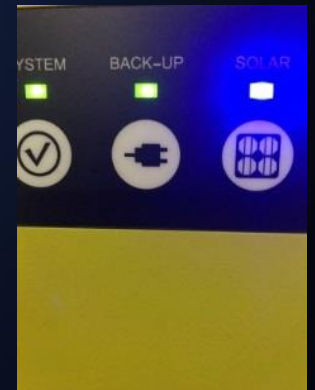

LV LG (3.3, 6.5, 10 and 13.5kWh) wiring

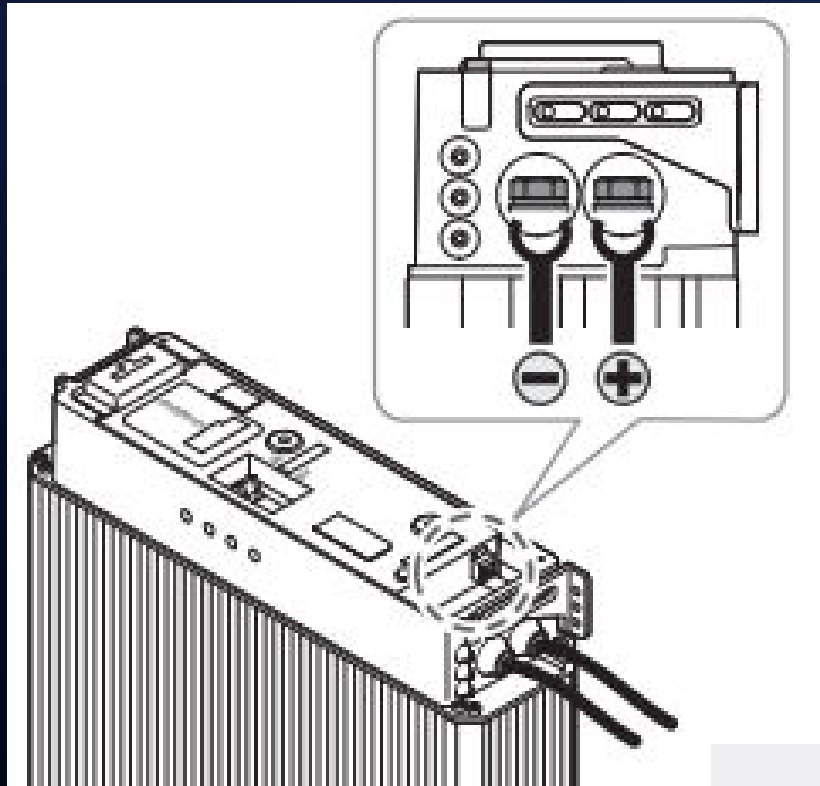

1. Always check battery power cable polarity in advance !

2. Link data cable from inverter to LG

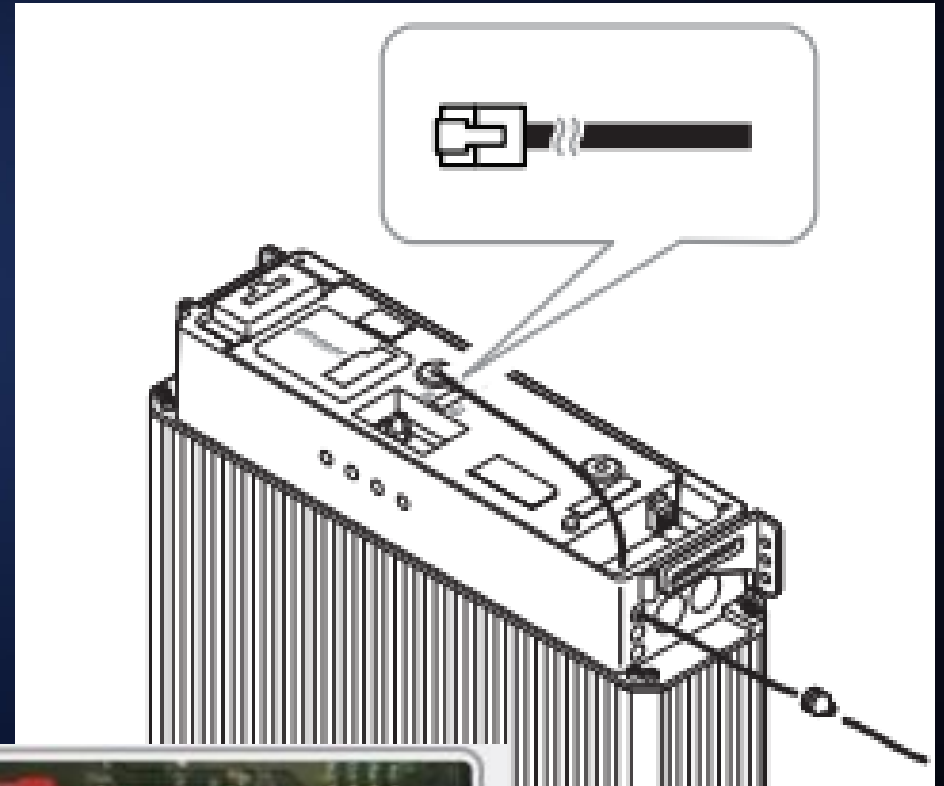

3. Set up Dip Switches correctly

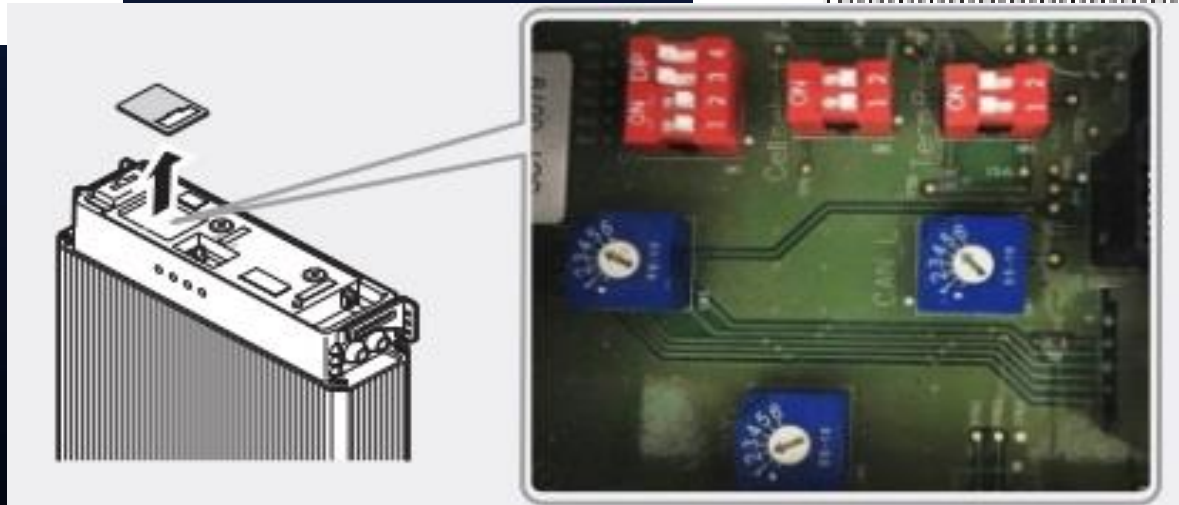

BYD LV (3.5kWh per stack) wiring

Always check battery power cable polarity in advance !

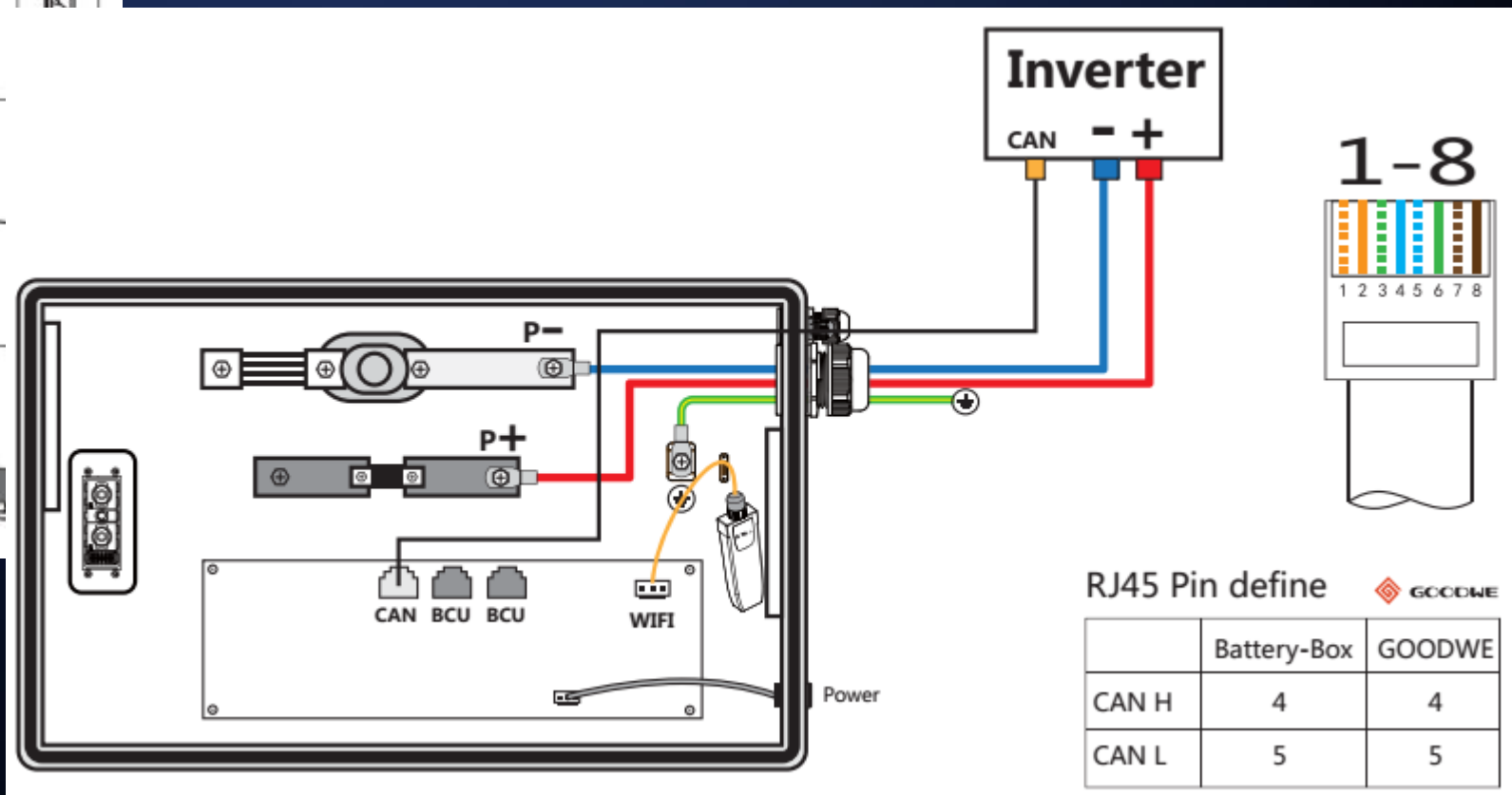
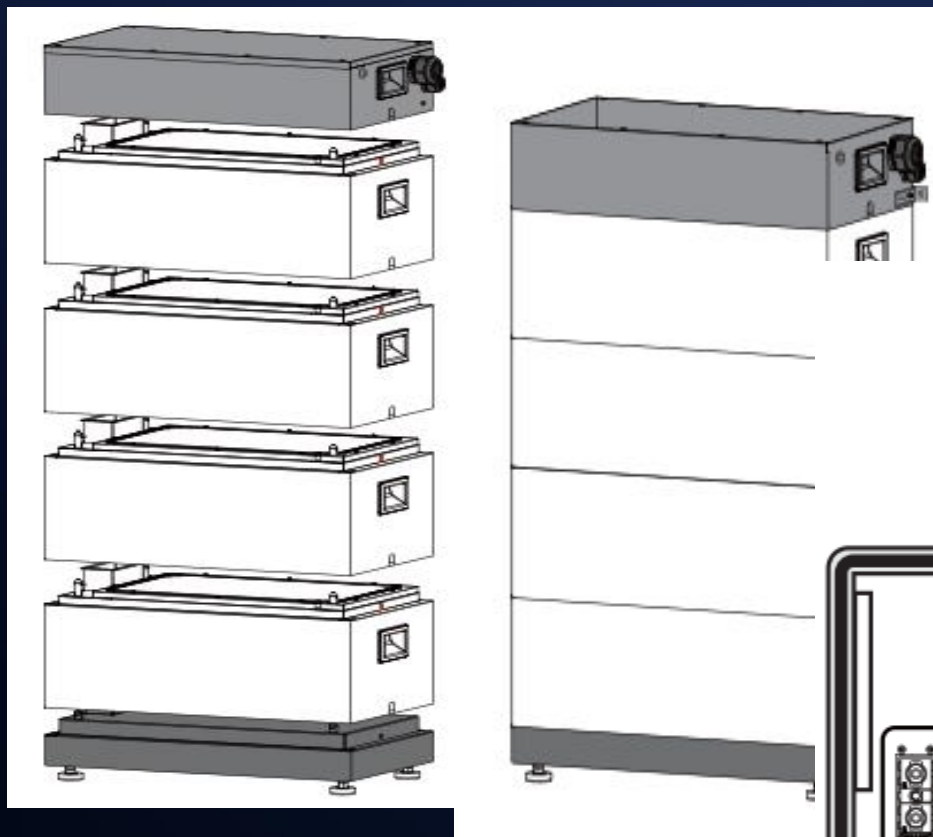

Link power cable, data cable

BYD HVM wiring

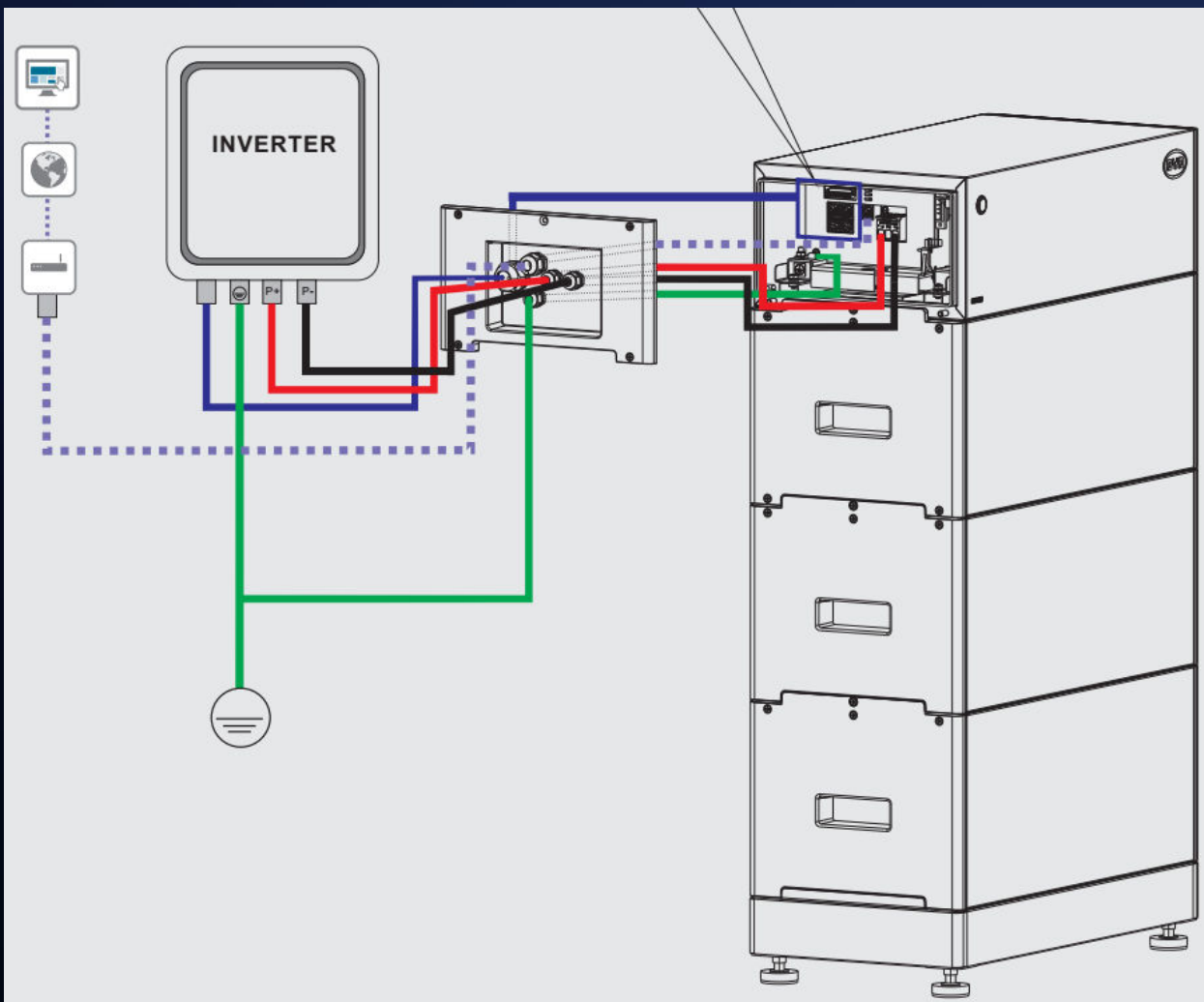

1. Always check battery power cable polarity in advance !

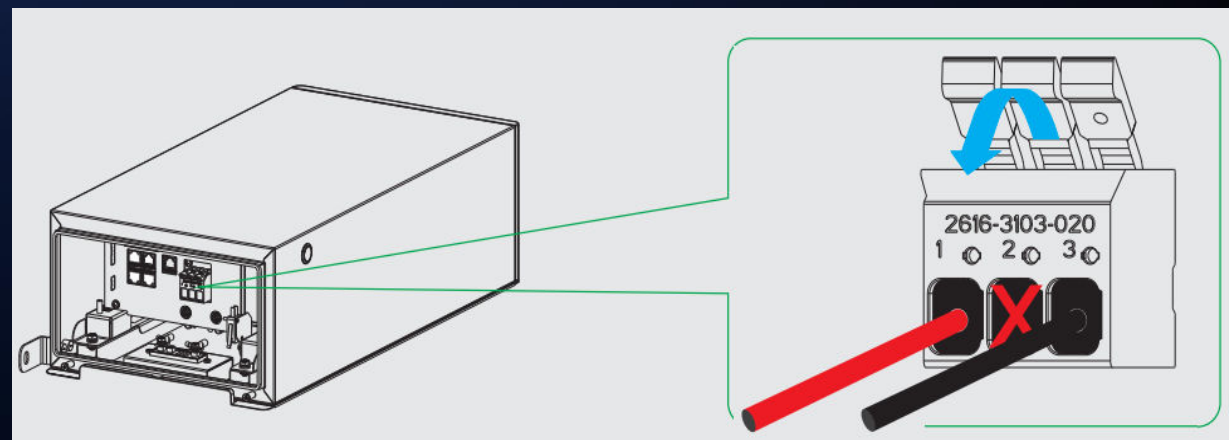

BYD HVM wiring

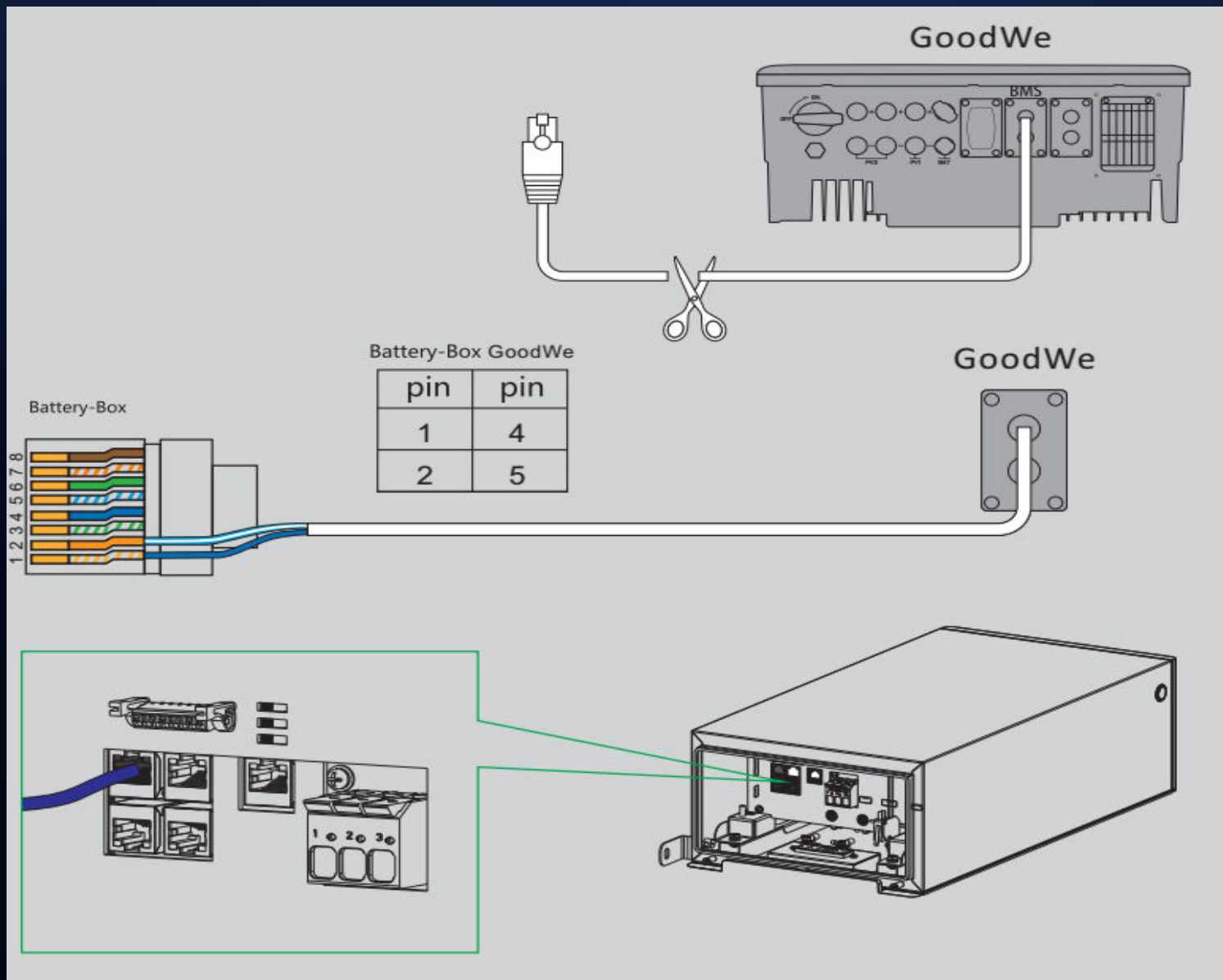

BYD HVM wiring

2. BMS cable option 2

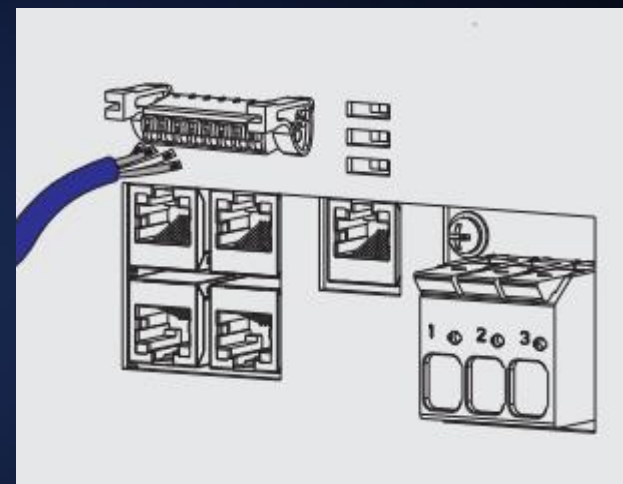
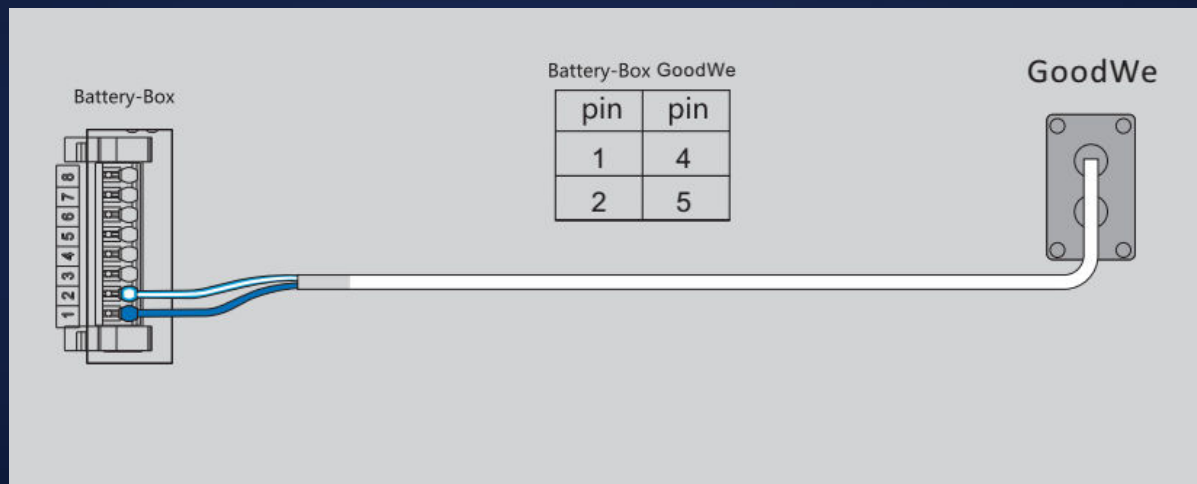

3. Put three Dip switches to left hand side



4. BYD APP for commissioning HVM battery

The image displays four sequential screenshots of the BYD APP commissioning interface:

- Screen 1:** "Select Application Language" with a dropdown menu set to "English" and a "Confirm" button.
- Screen 2:** "Welcome to Be Connect! to configure your Battery-Box Premium" with an image of the battery box and a "Battery Box" icon at the bottom.
- Screen 3:** "Privacy Policy of SHEN ZHEN BYD ELECTRONIC CO.,LTD" with "Responsible for data processing (controllers):" and buttons for "Confirm", "Cancel", and "Download".
- Screen 4:** A vertical bar representing the battery status and a "Start configuration" button at the bottom.

04

Commissioning

System Commission

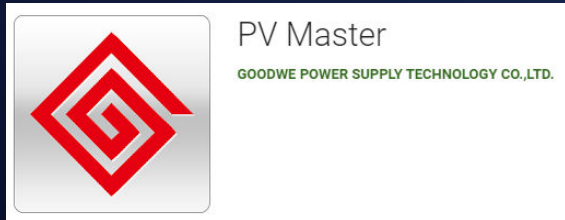

Download the PV Master app
Connect to Solar-Wi-Fi
(PW:12345678)
APP detect products
automatically

Installer password:
goodwe2010

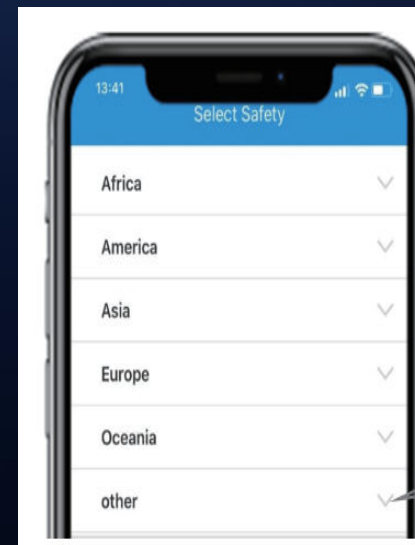
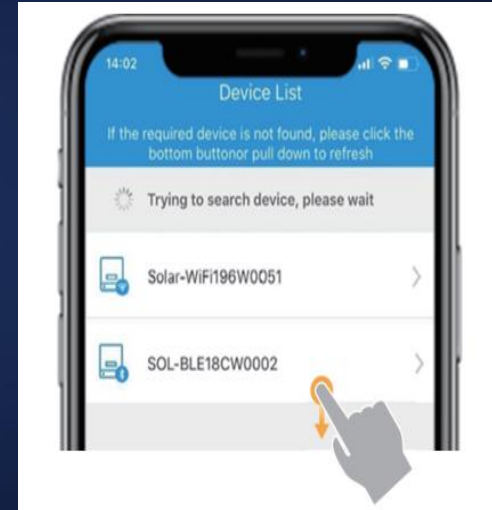
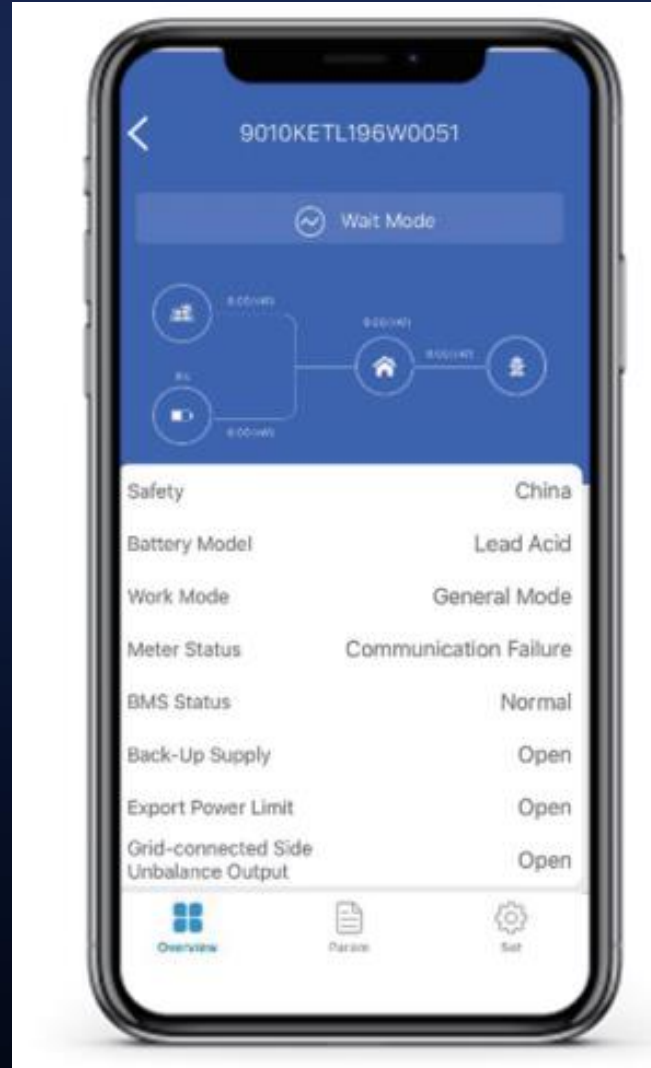

→ Select Safety Code:

Please select the right safety code based on your installation area. If it is not on the list, then please find one in "Other"



System Commission

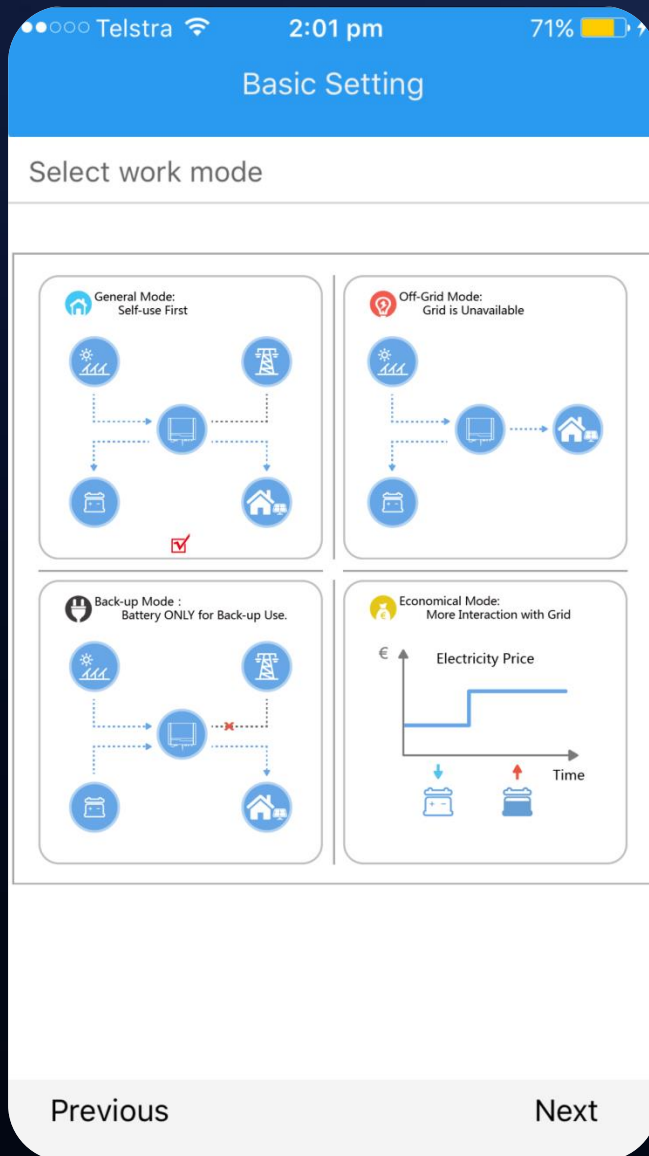

1. General model:
self consumption
2. Off grid model:
off grid use
3. Back up model:
Battery only discharge
when black out happens
4. Economic model:
define the charge/discharge period.



System Commission – Meter test

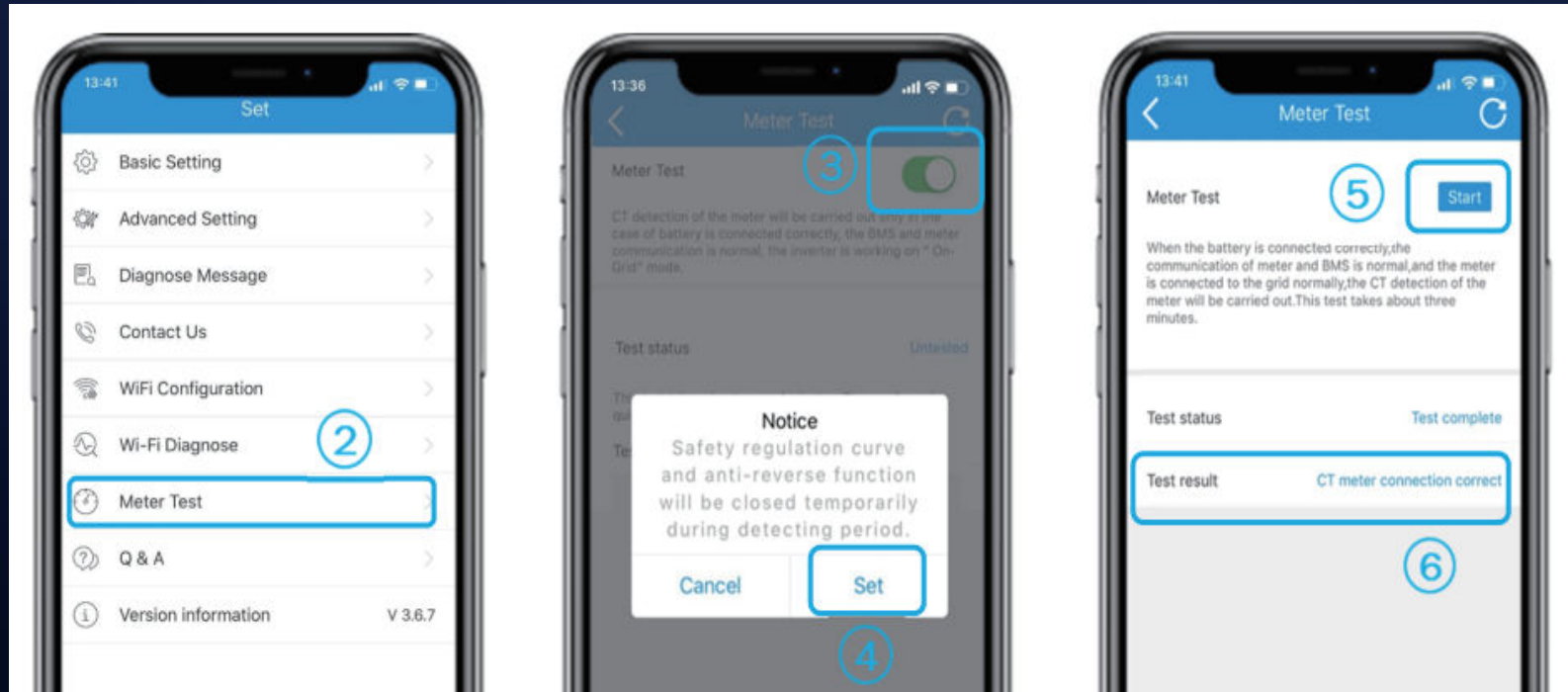

Meter Test: to check whether the CT is reversed

System Review

Meter Communication:

Meter part shall be show Untested or Test complete

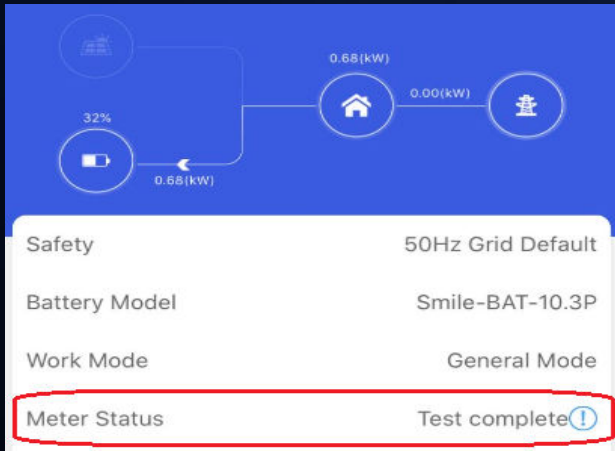
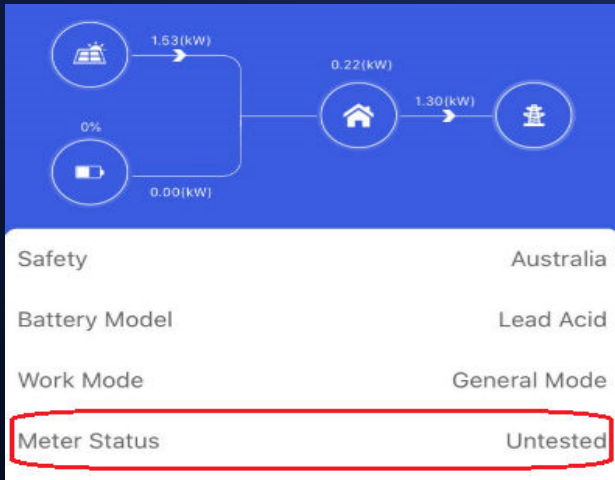

Battery BMS Communication:

BMS status shall be always Normal

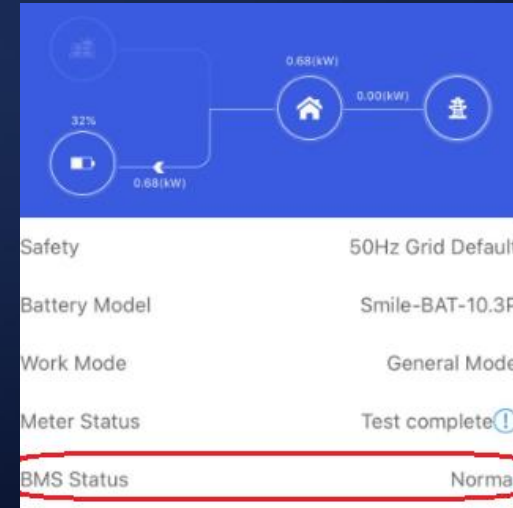

Battery Power Reservation Solution

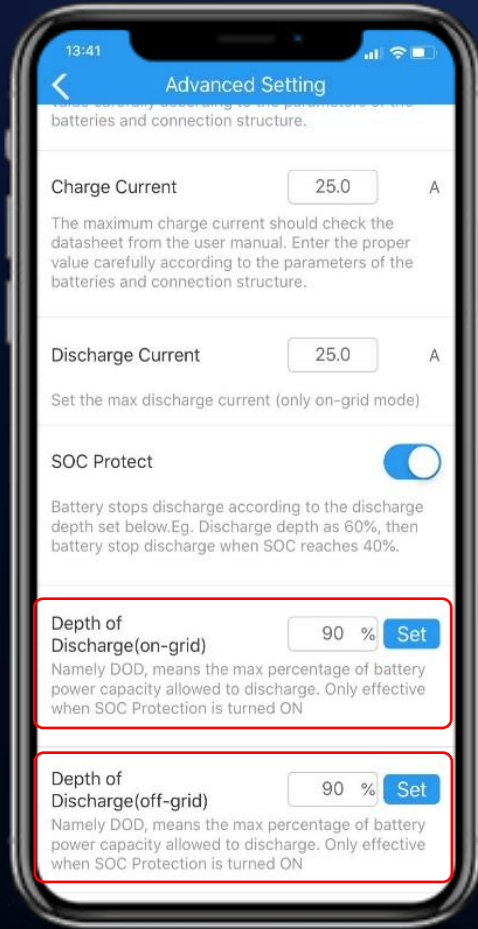

Set different DOD levels for off-grid & On-grid conditions

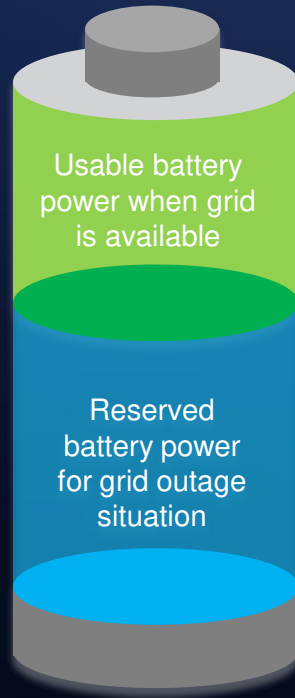

Choose "Back-Up Mode"

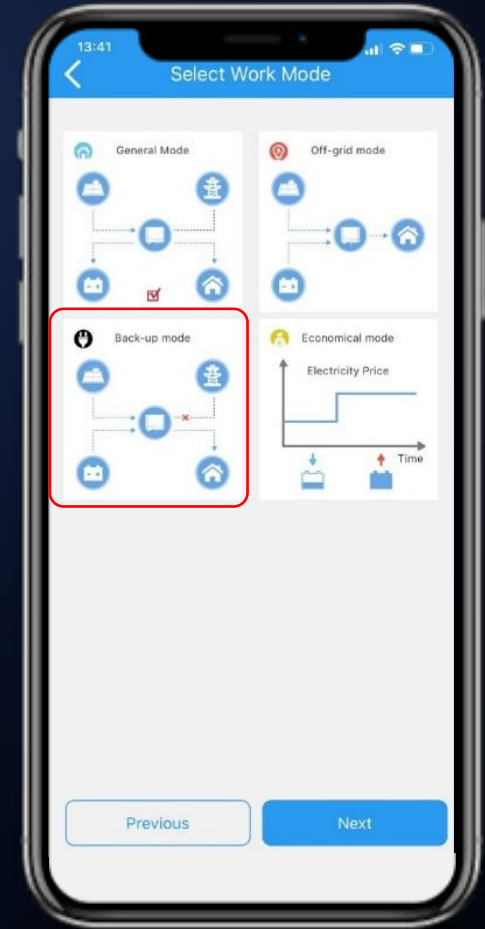
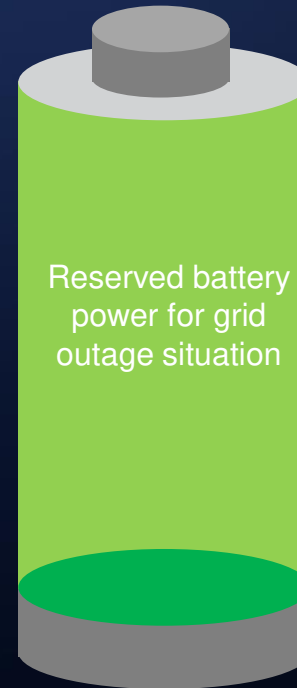

Quick Installation & Commissioning

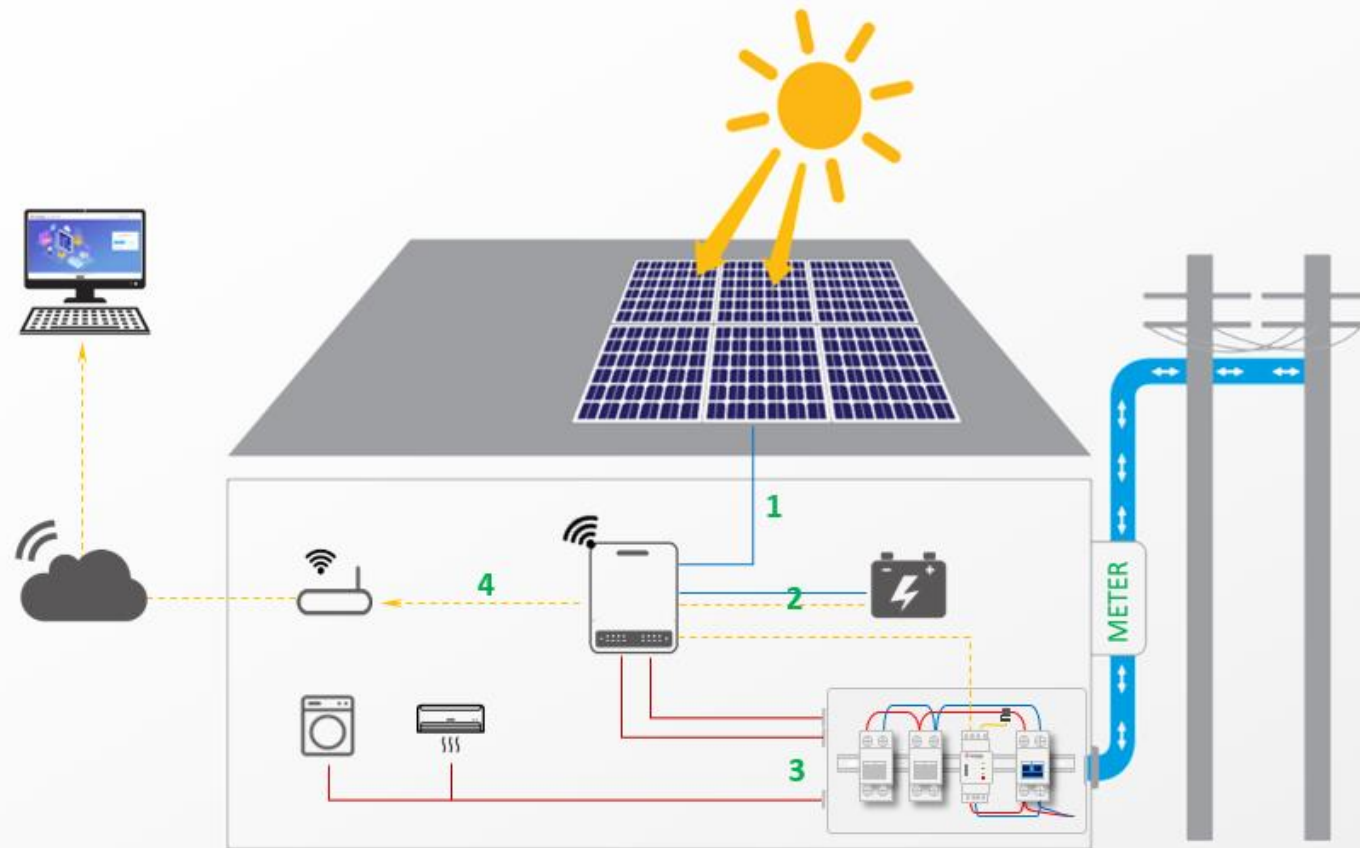

Expected Building-up Time with experienced hands with proper tools

No.	Install/Commission	Time
1	PV Connection	3'~5'
2	Battery Connection (Power & Comm. cable)	6'~8'
3	AC Grid Connection (Grid & On-grid loads)	Depends (5'~15')
	Backup Connection	4'~ 8'
	Meter + CT connection	2'~ 3'
	Meter Comm.	20''
4	Wi-Fi Configuration	1'
	APP Setting	1'~2'

Total: 22~45 Mins

ES, EM, SBP, EH, ET architecture

Quick installation guide
LV inverter / HV inverter

Commissioning check list

EHQUICK INST

PART 1

QUICK
INSTALLATION

INSTRUCTIONS

PART 3

WI-FI
CONFIGURATION

Task	Check Ticket
<u>Physical Power connection</u>	
Battery physical connected (polarity)	<input type="checkbox"/>
AC cable connect on inverter	<input type="checkbox"/>
(optional) if using back up, the back up neutral has been linked together with grid neutral	<input type="checkbox"/>
<u>Data Cable connection</u>	
Data cable to the batteries	<input type="checkbox"/>
(optional) Multi-batteries have been set up correctly associating with battery manual	<input type="checkbox"/>
LG dip switch has been put on right position	<input type="checkbox"/>
Data cable to the ezmeter	<input type="checkbox"/>
Ezmeter CT clamp position (between main breaker and meter)	<input type="checkbox"/>
Ezmeter CT clamp orientation (House to Grid)	<input type="checkbox"/>
(optional) Three phases Ezmeter, CTs and power reference cables are in right order	<input type="checkbox"/>
<u>Turn the System On and Run PV master APP</u>	
Country, model, battery type has been defined in basic setting	<input type="checkbox"/>
(optional) back up supply on in advanced	<input type="checkbox"/>
<u>System Check and Review</u>	
Meter Status is Untest or Completed	<input type="checkbox"/>
(optional) Meter test is OK	<input type="checkbox"/>
Battery BMS status Normal	<input type="checkbox"/>
Charging test	<input type="checkbox"/>
Discharging test	<input type="checkbox"/>
(optional) Back Up test	<input type="checkbox"/>
<u>WiFi set up</u>	
The WiFi LED light is solid on	<input type="checkbox"/>
Register customer account on SEMS portal	<input type="checkbox"/>

04

Monitoring

WiFi Connection

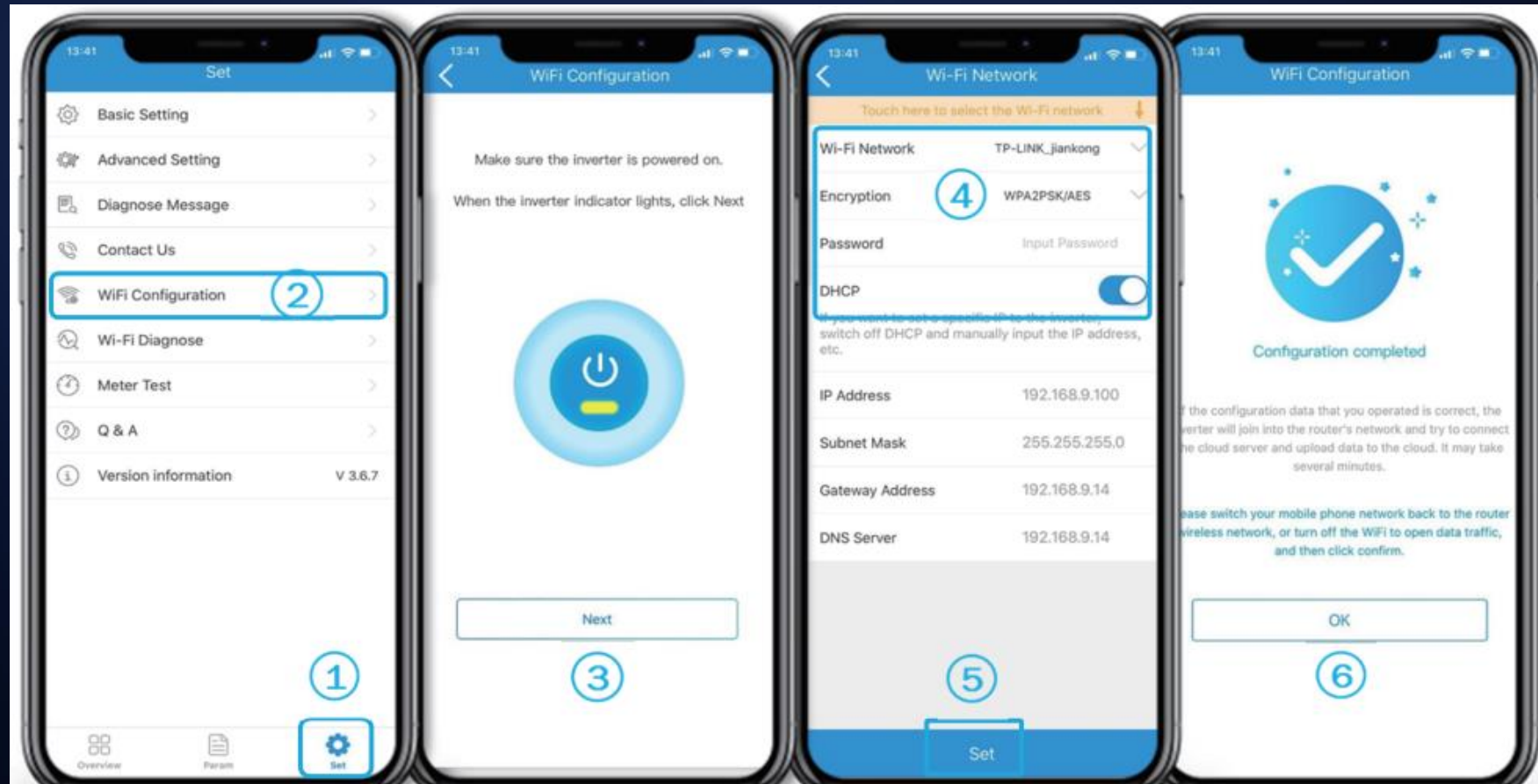

SYSTEM	BACK-UP	SOLAR	BATTERY	GRID	ENERGY	Wi-Fi	FAULT
Green	Green	Blue	Blue	Blue	Yellow	Yellow	Red

Hints:

Once the WiFi set up procedure has finished, the WiFi LED light on inverter will be steady ON.

Account Registration

← → ↻ <https://www.semsportal.com/home/login> 🔑 🗨️ ☆ 🌐 G

 **GOODWE**
YOUR SOLAR ENGINE

 **SEMS PORTAL**

[Demo](#) | [Operation Guide](#) | [What's new?](#) | [GDPR Contacts](#) | [Lang](#)

Rich Common Reports

- Flexible range selection: Plants, locations or organizations
- Free time dimension: Monthly, annual or user-defined
- Generate reports quickly to meet your needs





 Remember

04

Popular Questions

Frequent Questions

Question:

Can we use Goodwe storage to be an off grid system / can Goodwe connect to the generator?

Answer:

- ✓ Simple answer: No
Reason: generator, system design etc
- ✓ But...

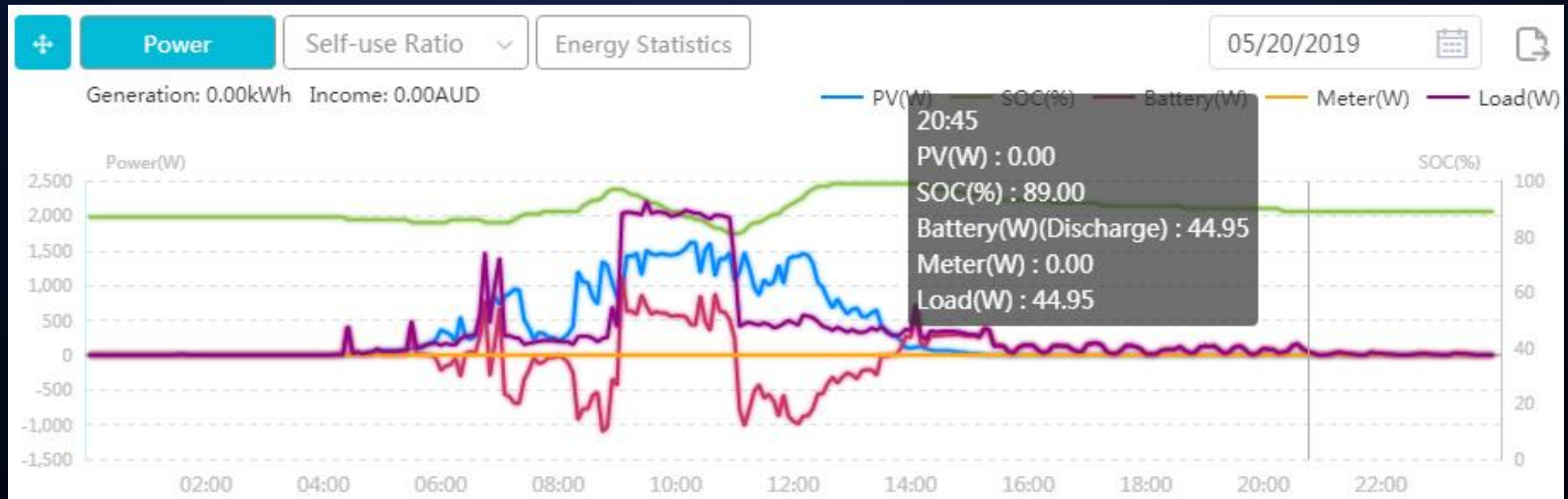

Paralleling Solution – 3 phase

three-phase **ET** hybrid inverter can be paralleled up to 100kW via the SEC1000 hybrid

- **Max 100kW**
- **Unbalance Output**
- **Smart Control**

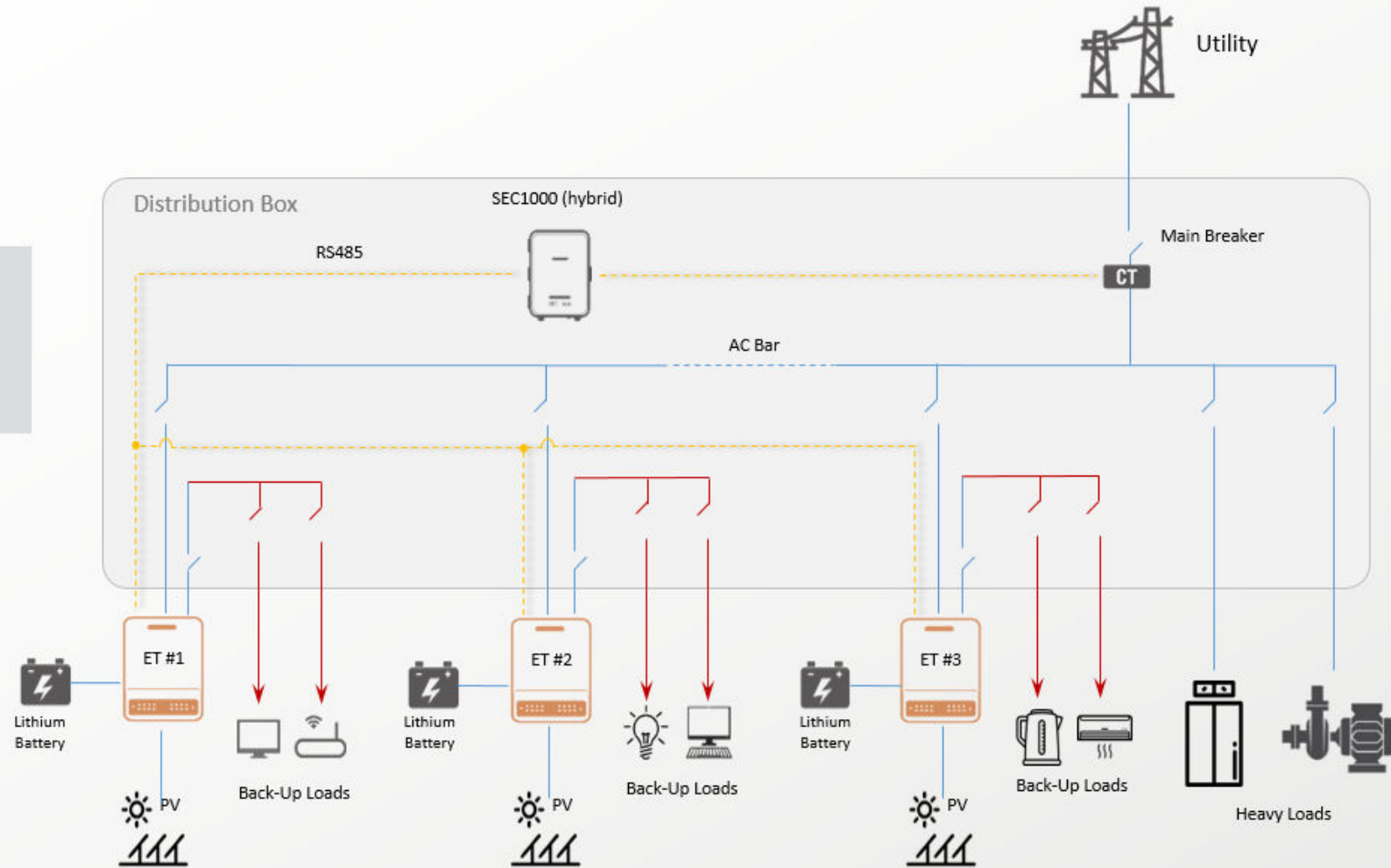



2020
THANK YOU

GOODWE, GOOD CHOICE