



## Gen 3 Wall Connector Manual

Type 2 Handle



Important Safety Information .....	2
Product Specifications .....	5
Wall Connector Label .....	6
Power Supply Options .....	7
Using Wall Connector .....	10
Features .....	11
Connectivity.....	11
Hosted Access Point .....	11
Local Network .....	11
Residual Current Device (RCD).....	12
Ground Monitor Interrupter.....	12
Power Outages .....	13
Firmware Updates .....	13
Thermal Monitoring .....	13
Wall Connector External Components.....	14
Wall Connector Internal Components .....	15
In the Box .....	16
Tools .....	17
Installation Considerations .....	18
Installation Steps .....	21
STEP 4: Sizing and Routing Conductor Wires.....	22
STEPS 1, 2, 3: Preparing and Mounting the Wirebox... .....	23
STEP 5: Stripping and Securing Wires in Wirebox Terminals....	25
STEP 6: Securing Main Unit to Wirebox .....	27
Commissioning Procedure.....	28
Power Sharing .....	30
Power Sharing Overview .....	30
Breaker and Branch Circuit Setup.....	31
Considerations for Power Sharing .....	32
Calculating Power Sharing Requirements for Existing Systems	32
Wall Connector LEDs .....	33
Light Codes .....	33
Error Codes.....	34
Warranty Information.....	36
Limits of Liability .....	37
Dispute Resolution .....	38



## IMPORTANT SAFETY INFORMATION

Read all instructions before using this product. Save these instructions. Wall Connector features built-in RCD Type A + DC 6mA.

This manual contains important instructions for the Tesla Gen 3 Wall Connector that shall be followed during installation, operation, and maintenance. Please review all warnings and cautions before installing and using the Wall Connector.



**WARNING:** When using electric products, basic precautions should always be followed, including the following.

### INSTRUCTIONS RELATING TO RISK OF FIRE OR ELECTRIC SHOCK



**WARNING:** Do not install or use the Wall Connector near flammable, explosive, harsh, or combustible materials, chemicals, or vapors.



**WARNING:** Turn off power at the circuit breaker before installing or cleaning the Wall Connector.

### WARNINGS



**WARNING:** This device should be supervised when used around children.



**WARNING:** The Wall Connector must be earthed through a permanent wiring system or an equipment-earthing conductor.



**WARNING:** Use the Wall Connector only within the specified operating parameters.



**WARNING:** Never spray water or any other liquid directly at the wall mounted control box. Never spray any liquid onto the charge handle or submerge the charge handle in liquid. Store the charge handle in the dock to prevent unnecessary exposure to contamination or moisture.



**WARNING:** Do not use the Wall Connector if it is defective, appears cracked, frayed, broken, or otherwise damaged, or fails to operate.



**WARNING:** Do not use the Wall Connector if the flexible power cord or cable is frayed, broken, or otherwise damaged, or fails to operate.



**WARNING:** Do not attempt to disassemble, repair, tamper with, or modify the Wall Connector. The Wall Connector is not user serviceable. Contact Tesla for any repairs or modification.



**WARNING:** When transporting the Wall Connector, handle with care. Do not subject it to strong force or impact or pull, twist, tangle, drag, or step on the Wall Connector, to prevent damage to it or any components.



**WARNING:** Do not touch the Wall Connector's end terminals with fingers or sharp metallic objects, such as wire, tools, or needles.



## IMPORTANT SAFETY INFORMATION



**WARNING:** Do not insert fingers or foreign objects into any part of the Wall Connector.



**WARNING:** Do not forcefully fold or apply pressure to any part of the Wall Connector or damage it with sharp objects.



**WARNING:** Use of the Wall Connector may affect or impair the operation of any medical or implantable electronic devices, such as an implantable cardiac pacemaker or an implantable cardioverter defibrillator. Check with your electronic device manufacturer concerning the effects that charging may have on such electronic devices before using the Wall Connector.



## IMPORTANT SAFETY INFORMATION

### CAUTIONS



CAUTION: Do not use private power generators as a power source for charging.



CAUTION: Incorrect installation and testing of the Wall Connector could potentially damage the vehicle's battery, components, and/or the Wall Connector itself. Any resulting damage is excluded from the New Vehicle Limited Warranty and the Charging Equipment Limited Warranty.



CAUTION: Do not operate the Wall Connector in temperatures outside its operating range of -30° C to 50° C (-22° F to 122° F).



CAUTION: Wall Connector should only be installed by personnel who are trained and qualified to work on electrical systems.



CAUTION: Ensure that Wall Connector is within storage temperature when moving, transporting, or storing.



## PRODUCT SPECIFICATIONS

This manual applies to Wall Connectors identified by part number 1529455-\*\*-\*\*.\*.

Voltage and Wiring	1-phase 230 V L-N 3-phase 230 V L-L 3-phase 400 V L-L
Current Output Range	Maximum 32 A (adjustable by installer)
Terminal Blocks	Stranded: 4-25 mm <sup>2</sup> , copper only Solid: 1.5-20 mm <sup>2</sup> , copper only
Supported Earthing Scheme	TN/TT/IT
Frequency	50/60 Hz
Cable Length	7.3 m (24 ft)
Wall Connector Dimensions	Height: 345 mm (13.6 in) Width: 155 mm (6.1 in) Depth: 110 mm (4.3 in)
Wire Box Bracket Dimensions	Height: 250 mm (9.8 in) Width: 120 mm (4.7 in) Depth: 50 mm (2.0 in)
Weight (including wirebox)	6.8 kg (15 lb)
Operating Temperature	-30°C to 50°C (-22°F to 122°F)
Storage Temperature	-40°C to 85°C (-40°F to 185°F)
Enclosure Rating	IP 44
Ventilation	Not required
Means of Disconnect	External branch circuit breaker
Residual Current Detection	Integrated (Type A + DC 6 mA)
Wi-Fi	2.4 GHz, 802.11b/g/n
Certifications	CE, IEC 61851-1 CB





## WALL CONNECTOR LABEL

Each Wall Connector has a label on the exterior side with information that is unique to the product, including:

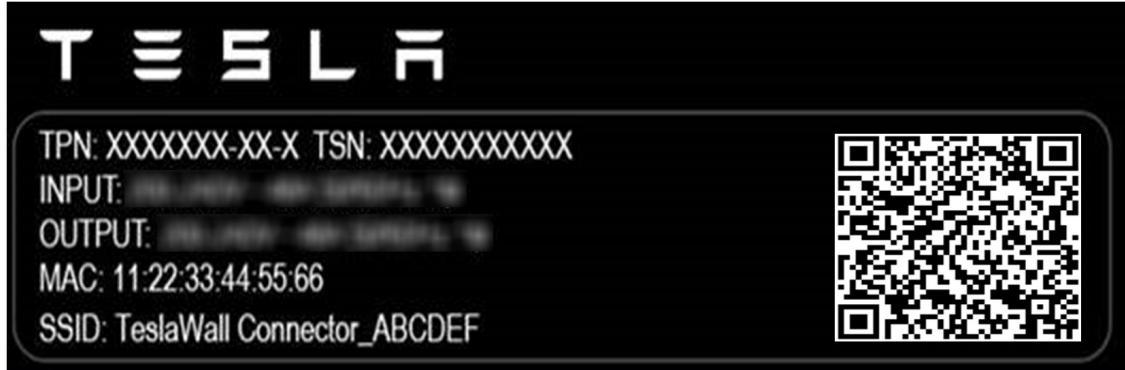

- TPN: Tesla Part Number
- TSN: Tesla Serial Number
- Input: Max input power
- Output: Max output power
- MAC: Unique MAC address assigned to the Wall Connector
- SSID: Unique Wi-Fi access point assigned to the Wall Connector



## POWER SUPPLY OPTIONS

For basic operation, Wall Connector requires an electrical connection to Line 1, Neutral, and Protective Earth (PE) terminals. Connection to Line 2 and Line 3 terminals is supported for some grid types.

**CAUTION:** Wall Connector supports 230 V L-N (+/- 10%). Mis-wiring the neutral terminal with >264V to PE can damage Wall connector

Wall Connector can operate on a three-phase power supply or a single-phase power supply.

Table 1. Most Common Installation Option

Wiring Configuration Option for Five Wires: Line 1, Line 2, Line 3, Neutral, PE

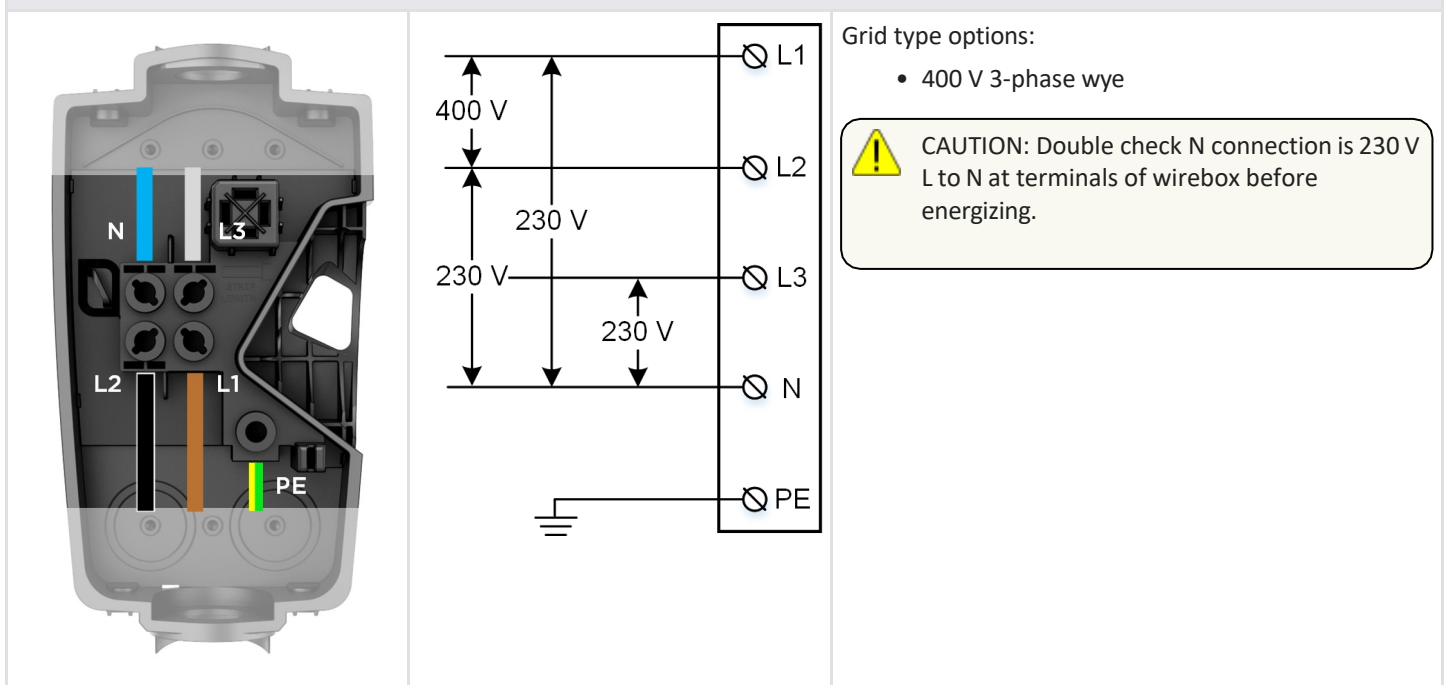

**NOTE:** Blue is used as the IEC standard for neutral. Some markets may use other colors to symbolize neutral and line conductors.



# POWER SUPPLY OPTIONS

Table 2. 2nd Most Common Installation Option

Wiring Configuration Option for Three Wires: Line 1, Neutral, PE

		<p>Grid type options:</p> <ul style="list-style-type: none"><li>• 230 V Line to Neutral</li><li>• 230 V Line to Line</li></ul> <p> NOTE: For 230V Line to Line connections, without a Neutral, connect one Line from the grid to the Neutral terminal of the wirebox</p> <p> CAUTION: Double check N connection is 230 V L to N at terminals of wirebox before energizing.</p>
--	--	--



# POWER SUPPLY OPTIONS

Table 3. Least Common, but Supported Installation Option

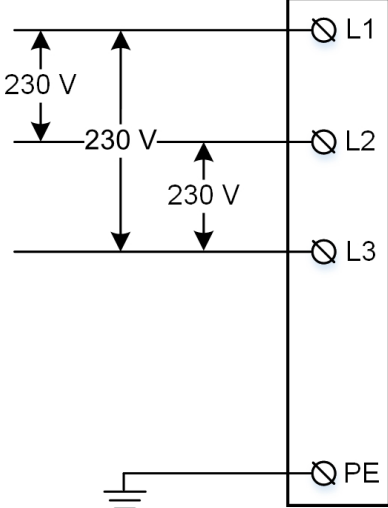
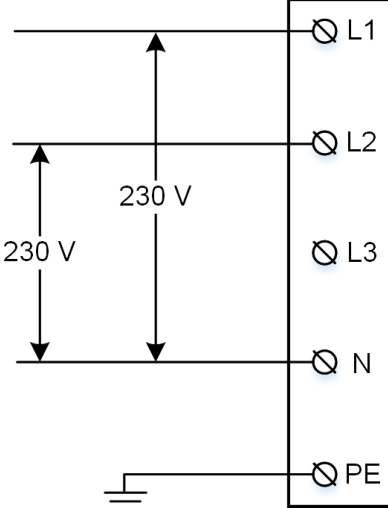
Wiring Configuration	Option for Four Wires: Line 1, Line 2, Neutral, PE	
 <p data-bbox="105 955 600 1050">*When connecting to a 230 V delta no neutral grid, land one of the line connections in the neutral terminal of the wirebox.</p>		<p data-bbox="1068 273 1266 304">Grid type options:</p> <ul data-bbox="1117 315 1453 493" style="list-style-type: none"> <li>• Delta 230 V Line to Line</li> <li>• Open wye with 230 V Line to Neutral</li> <li>• Split phase 230 V Line to Neutral</li> </ul> <div data-bbox="1071 520 1518 724" style="border: 1px solid black; padding: 5px;"> <p data-bbox="1079 535 1502 693"><b>NOTE:</b> In the case of a Delta grid connection, land one of the line conductors from the grid in the neutral terminal of Wall Connector wirebox.</p> </div> <div data-bbox="1071 735 1518 924" style="border: 1px solid black; padding: 5px;"> <p data-bbox="1079 745 1502 850"><b>NOTE:</b> The conductor with lowest voltage to Protective Earth (PE) should be connected to the Neutral terminal.</p> </div> <div data-bbox="1071 940 1518 1092" style="border: 1px solid black; padding: 5px;"> <p data-bbox="1079 955 1502 1081"><b>CAUTION:</b> Double check N connection is 230 V L to N at terminals of wirebox before energizing.</p> </div>
		



## USING WALL CONNECTOR

1. Open the vehicle charge port by pressing the button on the charge handle, pressing on the charge port door, using the mobile app, using the vehicle touchscreen, or by pressing and holding the trunk button on the keyfob.
2. Insert the charge handle into the vehicle charge port.
3. Check the vehicle controls to verify charging.
4. To remove the charge handle from the vehicle, press and hold the button on the handle to unlock the charge port.



NOTE: The vehicle must be unlocked for the charge handle to be removable.



5. Remove the charge handle from the vehicle charge port.
6. Wrap the charge cable counter-clockwise around the Wall Connector and insert the charge handle into the holster.





## FEATURES

### Connectivity

Wall Connector is equipped with Wi-Fi to communicate with local site routers, vehicles, mobile devices, other Wall Connectors, and other Tesla products.



### Hosted Access Point

Wall Connector hosts a WPA2 password-secured, 2.4 GHz, 802.11 Wi-Fi access point network to facilitate commissioning and connecting to other devices.

A unique SSID Wi-Fi network name and WPA2 password for connecting to the Wall Connector are printed on a label at the rear of the main unit, as well as on the front cover of the Quickstart Guide included in the box.



### Local Network

Connecting Wall Connector to a local Wi-Fi network enables it to receive over-the-air firmware updates, remote diagnostics access, and usage data tracking capability. A Wi-Fi connection is required for sites that utilize authentication, billing, and other property management features.

 NOTE: New features and functions will be added over time.

Wall Connector only supports WPA2/3-secured, 2.4 GHz, 802.11 infrastructure mode networks.



 NOTE: Networks that are not password protected are not supported. The Wall Connector will not display non-password protected networks in the options list. Open networks without a password are not supported and will not be recognized by the Wall Connector.

 NOTE: WPA enterprise will be supported in a future firmware update.

 NOTE: Property management features will be enabled via future firmware updates.

## Residual Current Device (RCD)

Wall Connector features built-in RCD Type A + DC 6mA.

AC earth fault interruption automatically detects an AC current mismatch between power delivery conductors that would indicate that current is flowing through the earth conductor. AC fault protection will trip at 20 mA.

DC earth fault interruption automatically detects DC leakage through earth. DC fault protection will trip at 6 mA.

User interaction such as pressing the cable button or unplugging from vehicle is required to clear this fault. If fault continues, consult with an electrician to review power supply.

## Ground Monitor Interrupter

The ground monitor interrupter allows the installer to select different early monitor options. Wall Connector continuously checks for the presence of a safe earth connection and automatically recovers from faults.

Earth assurance operates by injecting a small amount of current into the earth conductor in order to measure the impedance between line and earth. If high impedance is detected, the Wall Connector will lock out charging and display a error code of two (2) red blinks. See [Error Codes on page 34](#) for a full list of error codes.

For earth assurance to operate on TN grids, one leg of the distribution transformer must be earth-bonded (Neutral). Earth bond should only occur at one location in a site's electrical system.

Wall Connector earth assurance may be adjusted in countries with TT or IT grid configurations and can be disabled in the commissioning procedure.

The Earth Monitor Interrupter feature monitors the Wall Connector earth connection. Select the correct option based on the installation's earthing system and earth impedance.

Depending on country, three options are available:

- Enable: Earth connection will be monitored and a high detected earth resistance will disable the Wall Connector. This is the preferred setting to provide protection, and should be selected where earth connection is expected to be strong (as in the case on TN networks and most TT networks), and where required by regulation.
- Disabled: Earth connection will not be monitored. This should be selected where the earth connection is not made (as is the case for IT networks), or where the current induced by this check would be problematic (as is the case on some TT networks with sensitive residual-current devices).

Temporary problems such as earth faults or utility power surges are resolved automatically.

## Power Outages

If there is a power outage while Wall Connector is charging a vehicle, charging will automatically resume within 1 to 3 minutes after power restoration. The Wall Connector will display a solid blue light on the faceplate to indicate that it is communicating with the vehicle and waiting to resume charging. Alternatively, pressing the button on the charge handle after power restoration will cause Wall Connector to resume charging immediately.

## Firmware Updates

Firmware updates will be automatically applied to the Wall Connector to improve the user experience and introduce new features. Connect Wall Connector to Wi-Fi for access to the most recent firmware update. See [Commissioning Procedure on page 28](#).

## Thermal Monitoring

Wall Connector actively monitors temperatures in multiple locations while charging to ensure stability of the charge session. Temperature sensors are located at the relays, microcontroller, charge handle, and rear of the main unit to monitor the temperature of the terminals in the wirebox.

In warmer conditions, Wall Connector may reduce current and charge speed to protect itself. When this happens, the light bar on the faceplate will continue to display the “streaming green” and a blink code of three red flashes to indicate that charging has been reduced due to high temperatures. If heat continues to rise, Wall Connector will stop charging and display a blink code of three red flashes.



NOTE: See [Error Codes on page 34](#) for full list of error codes.

For optimal performance, install Wall Connectors in areas where ambient temperature will remain below 50°C (122°F). In rare circumstances, Wall Connector may begin reducing amperage at 35°C (95°F) ambient temperatures. Adjustments to amperage are automatic and do not require user input; Wall Connector will return to starting current when temperatures are reduced.





## WALL CONNECTOR EXTERNAL COMPONENTS

"Wall Connector" refers to the product as a whole.

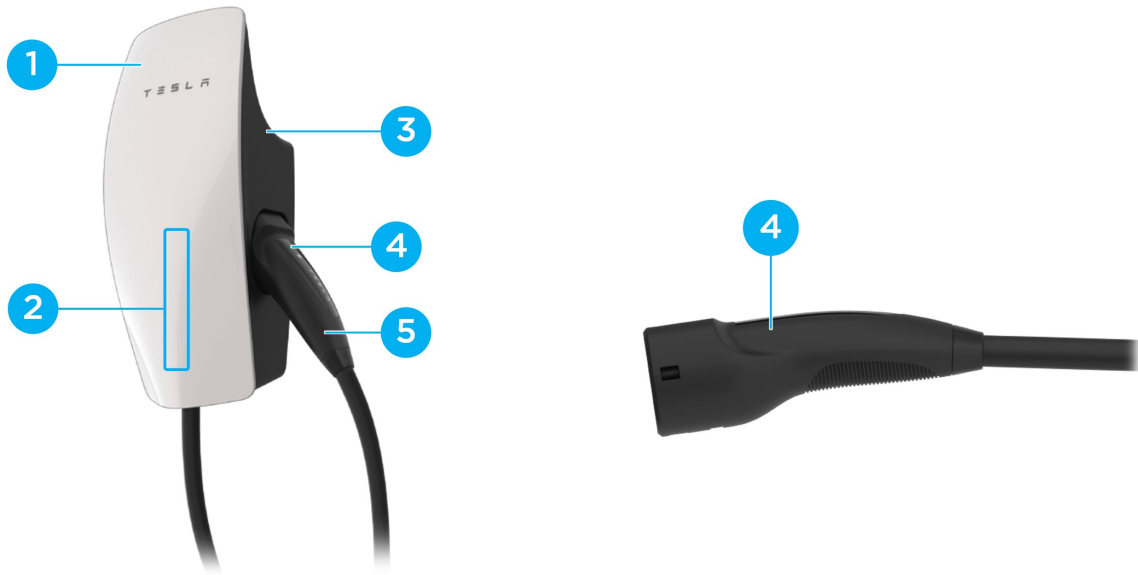

1. Faceplate
2. Light bar (vertical)
3. Main unit
4. Charge handle button
5. Charge handle





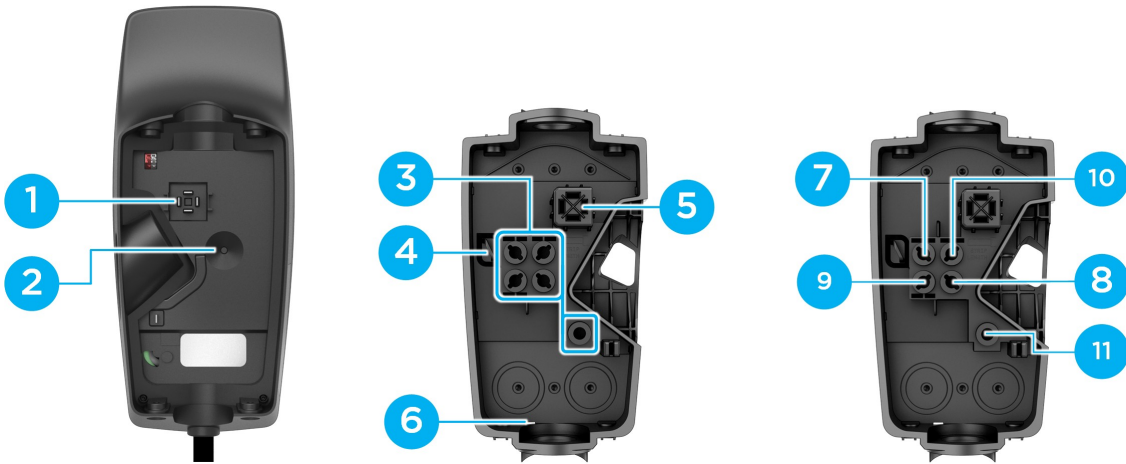





## WALL CONNECTOR INTERNAL COMPONENTS

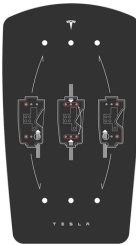

1. Contact blades
2. Temperature sensor
3. Conductor terminals
4. Zip tie anchor
5. Sliding contacts
6. Wirebox drainage opening (enables protection)
7. Neutral
8. Line 1
9. Line 2
10. Line 3
11. Earth



## IN THE BOX

 <p>Main Unit</p>	 <p>Wirebox</p>	 <p>Wirebox Mounting Template</p>	 <p>Hex Bit (4 mm)</p>
 <p>Zip tie (x1)</p>	 <p>Wall Connector-to-Wirebox Fastener (x4)</p>	 <p>Wirebox-to-Wall Fastener (x2) 4.0 x 50 mm (PZ2) (#8 x 2 in)</p>	 <p>Quickstart Guide (contains sticker with SSID network name and unique password)</p>

 NOTE: The hex bit, zip tie, and fasteners are located in a plastic bag inside the wirebox, which comes attached to the main unit of the Wall Connector.

 NOTE: Wall plugs are not included. If installing in concrete or other like materials, use 6 mm wall plugs.









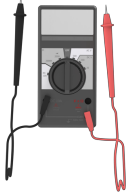

## TOOLS

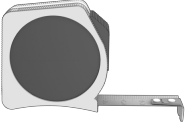
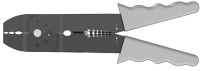

### Required Tools



NOTE: Drill bit sizes assume wood mounting surfaces. If installing on concrete or other masonry, consult with an electrician for optimal pilot hole sizes.

 Torque Driver (5.6 Nm, 50 lbf . in)	 Multimeter	 Stud Finder (If installing on wood walls)	 Tape Measure
 Wire Stripper	 Drill Bit, 5 mm (3/16 in) (If installing on wood walls)	 Drill Bit, 2.5 mm (3/32 in) (If installing on wood walls)	 Bit Driver
 Level	 Smartphone (with Wi-Fi)	 Power Drill	

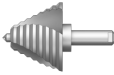
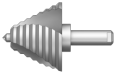
### Optional Tools

 Step Bit, 29 mm (1-1/8 in)	 Step Bit, 35 mm (1-3/8 in)	 Computer (with Wi-Fi)
---	---	--



## INSTALLATION CONSIDERATIONS

Wall Connector may be installed on any flat, vertical surface capable of supporting its weight (e.g. wall, pedestal, etc.). Wall Connector (wirebox, faceplate, and long cable) weighs 6.8 kg (15 lb).

### Choosing Location

Install Wall Connector in a location that allows the charge cable to reach the vehicle charge port without putting strain on the cable. Recommended installation area for Wall Connectors with 7.3 m (24 ft) 24 ft (7.3 m) cable:

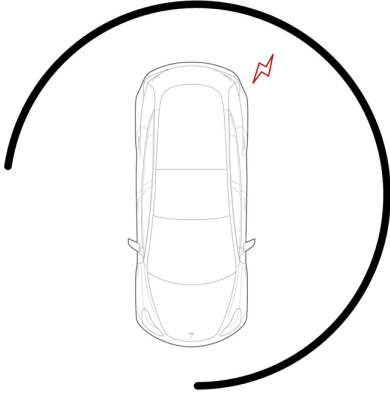

Install Wall Connector in a location with ample clearance on all sides to allow the charge cable to loop around the unit and the charge handle to comfortably land in the side dock.

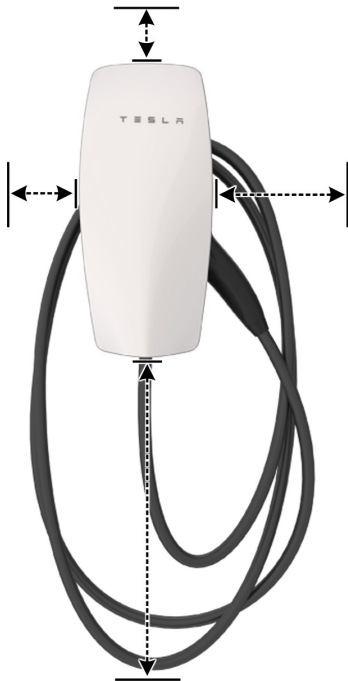

NOTE: If constrained by space, a cable organizer can be installed near the Wall Connector.



# INSTALLATION CONSIDERATIONS

## Choosing Height

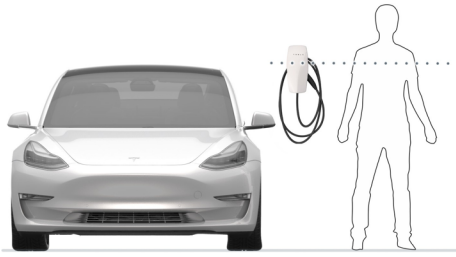

- Maximum height (indoor and outdoor): 1.52 m (60 in)
- Recommended height: ~1.15 m (~45 in)
- Minimum outdoor height: 0.6 m (24 in)
- Minimum indoor height: 0.45 m (18 in)

## Maximizing Wi-Fi Signal Reception

Wall Connectors should be connected to a local Wi-Fi network for optimal functionality. For maximum signal reception, avoid installing Wall Connector on opposite sides of concrete, masonry, metal studs, and other physical obstructions that could impede Wi-Fi signal reception.



NOTE: If a mobile device is able to connect to local Wi-Fi at a given location, it is a good indication that Wall Connector will also be able to connect.





## INSTALLATION CONSIDERATIONS

### Wire Entry Options



Wall Connector's wirebox has multiple wire entry options. Choose one entry path and follow installation instructions based on chosen entry path.

1. Top entry location
2. Rear entry locations (left or right)
3. Bottom entry location



## INSTALLATION STEPS





## INSTALLATION STEPS

### STEP 4: Sizing and Routing Conductor Wires

Pull excess wire first, then cut to length. Use a wire stripper to cut each conductor wire appropriately based on entry point and position. Attach the conduit/fittings and route each conductor wire into the wirebox so it lands in the correct terminal.

 NOTE: Insulation wire colors may vary based on market.

For Top Wire Entry

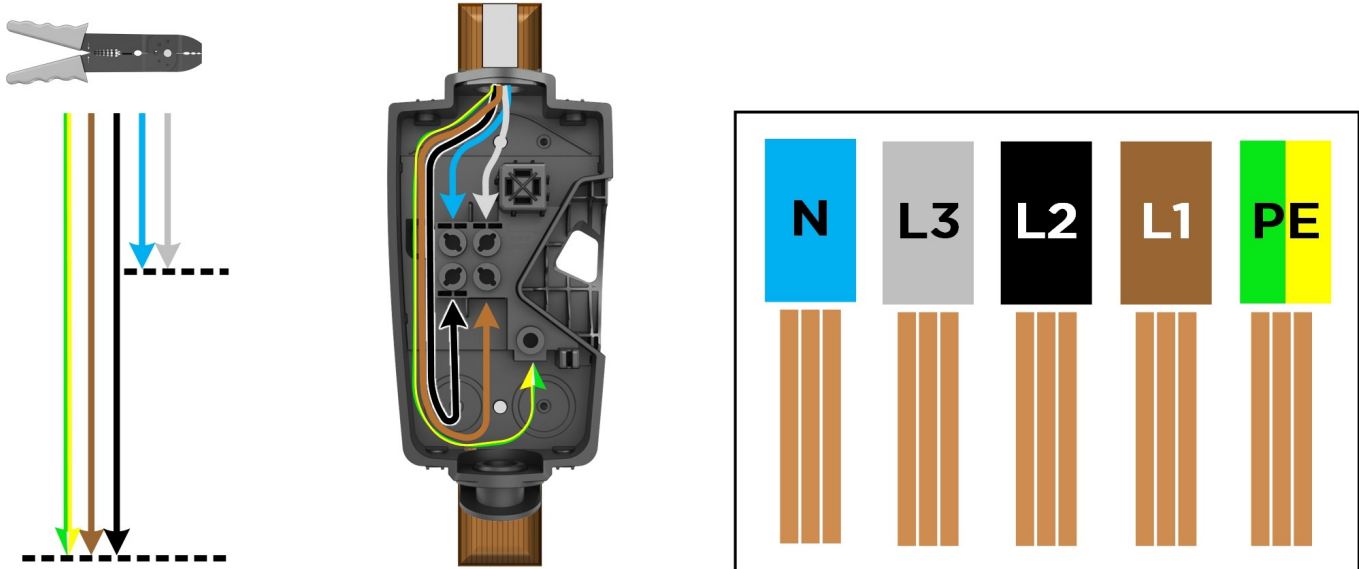

*Wire lengths/proportions shown are not to scale.*

For Bottom (1), Rear Left (2), or Rear Right (3) Wire Entry

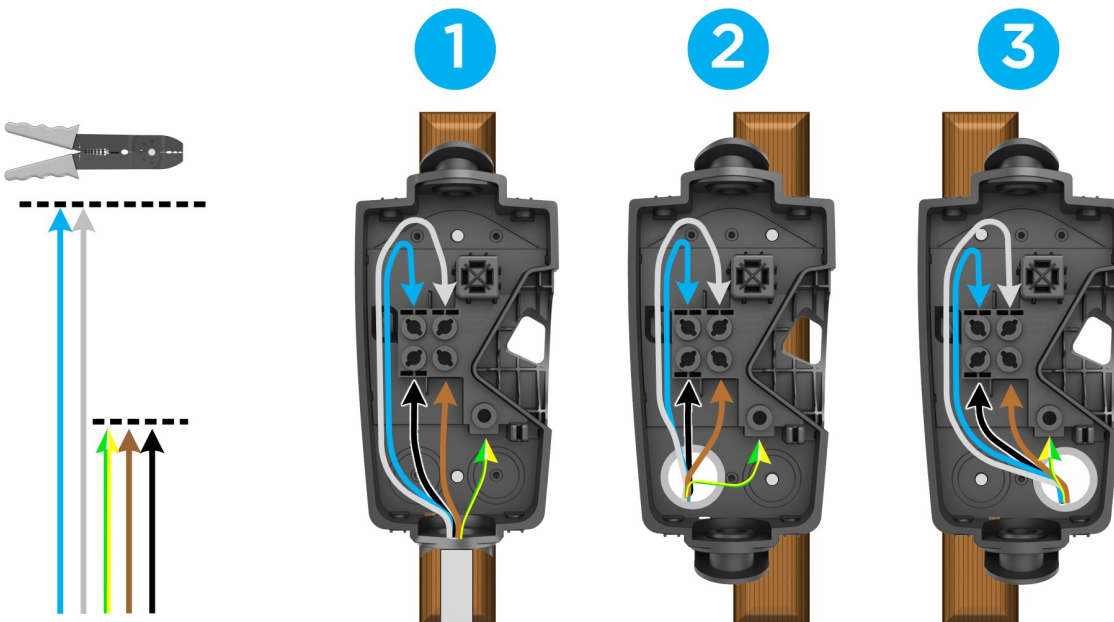

*Wire lengths/proportions shown are not to scale.*



# INSTALLATION STEPS

## STEPS 1, 2, 3: Preparing and Mounting the Wirebox

This procedure has 4 different variations depending on the chosen wire entry option, but the general order of steps will be the same for all wire entry options:

1. Drill 5 mm holes into the wirebox\*. If wiring for rear entry, use step bit.
2. Use cardboard template to plan or drill pilot holes into mounting surface\*. A 2.5 mm pilot hole is recommended for most surfaces.

NOTE: Drill larger pilot holes that can accommodate 6 mm wall plugs if installing on concrete, masonry, or similar materials.

NOTE: Installer can adjust pilot hole size based on mounting surface

NOTE: Use a level to ensure that the template is completely level.

3. Attach wirebox to mounting surface using included fasteners, which include an integrated sealing washer. The fastener head is compatible with both #2 Phillips or #2 square head bit. Attach conduit/ fittings and bring in conductor wires\*.

NOTE: It is the responsibility of the installer to select appropriate conduit/fitting materials for the installation.

\*Exact locations depend on the wire entry option

Table 4. For Top Wire Entry

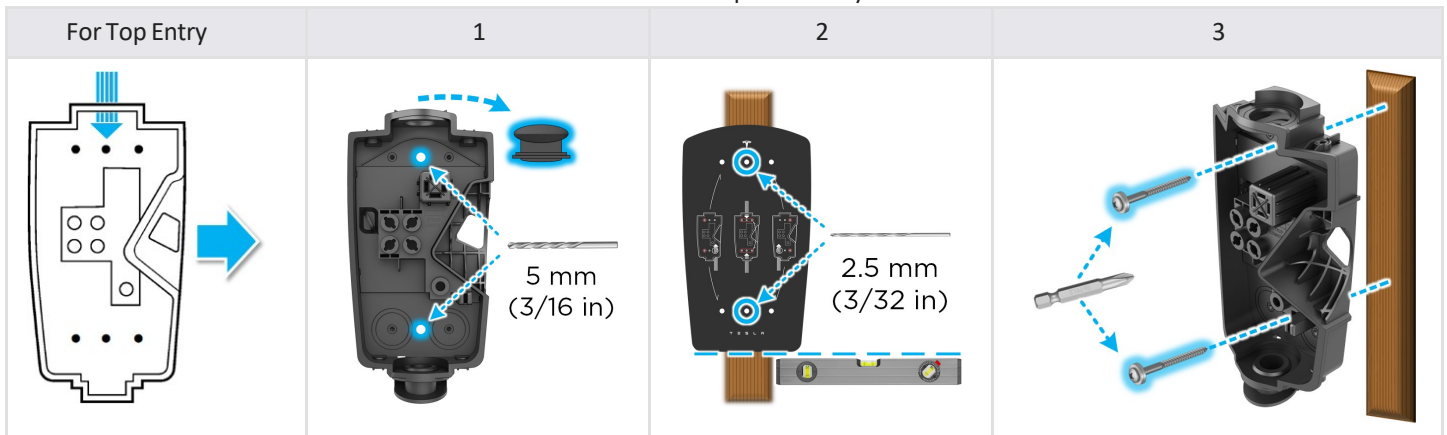
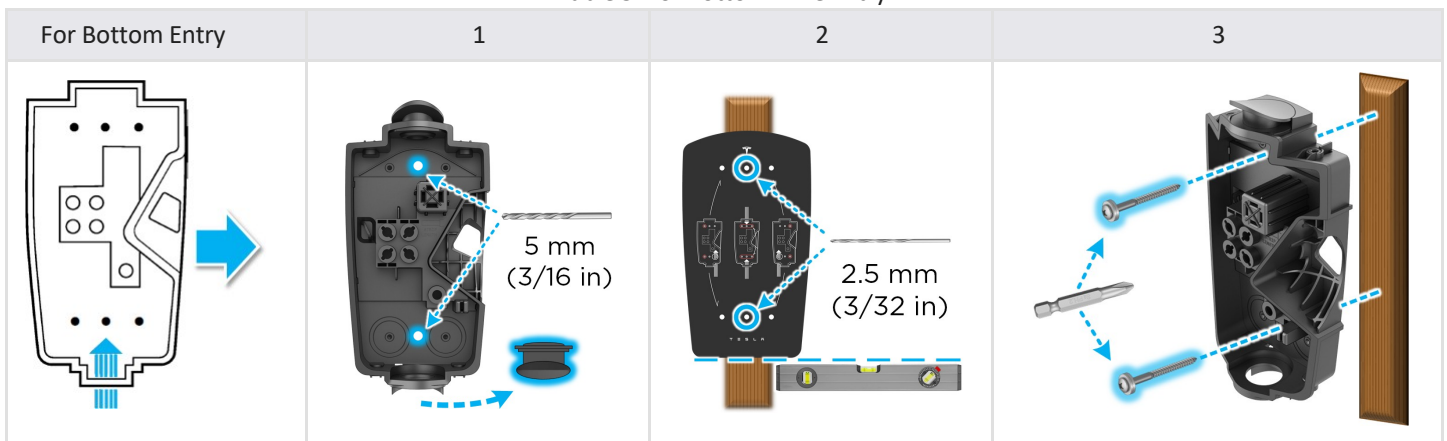

Table 5. For Bottom Wire Entry





# INSTALLATION STEPS

Table 6. For Rear Left Wire Entry

For Rear Left Entry	1	2	3

Table 7. For Rear Right Wire Entry

For Rear Right Entry	1	2	3



**CAUTION:** Wall Connector is IP 55 rated and does not need caulking. Refrain from using any bonding, sealant, or adhesives as part of the Wall Connector installation. The provided screws have sealant washers which provide adequate sealing.

Installer is responsible for providing appropriate glands, fittings, and conduit to secure incoming power supply to Wall Connector wirebox. Top and bottom entry are 28 mm in diameter when sealing plug is removed. If needed, bottom entry can be expanded using a step bit. Do not expand top entry.



## INSTALLATION STEPS

### STEP 5: Stripping and Securing Wires in Wirebox Terminals

1. Use a wire stripper to strip the ends of each wire to ~12 mm.

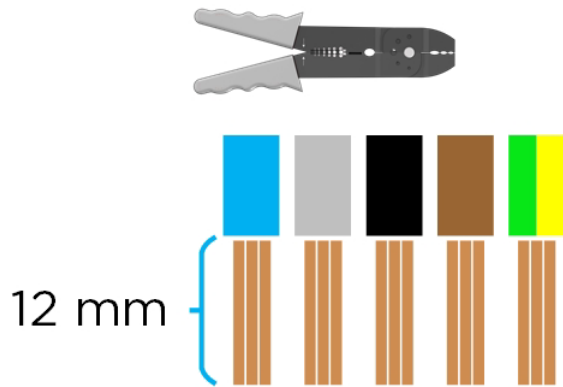

2. Insert each stripped wire into the correct terminal.



NOTE: If using stranded wiring smaller than 4 mm<sup>2</sup>, use a correctly sized ferrule so it can be securely terminated.

3. Use the included bit to torque each terminal to 5.6 Nm (50 lbf.in). Use zip ties to secure wires to service loop on the left side of the wirebox.

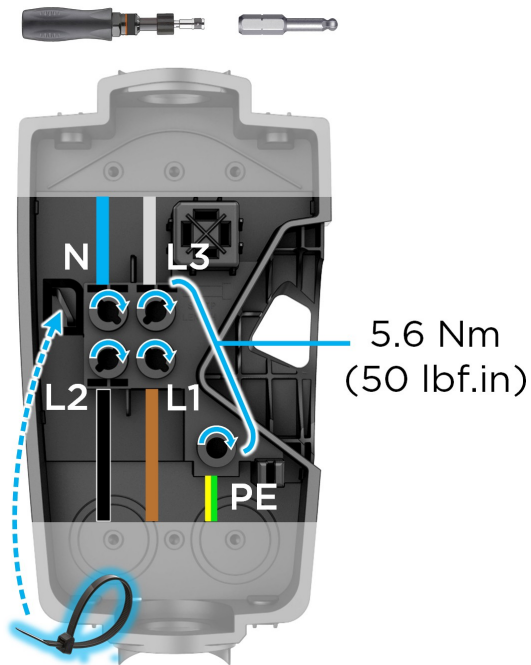



## INSTALLATION STEPS

4. Use scissors to cut excess plastic off zip tie after securing in place. Ensure no wiring or other obstruction crosses over the terminal block screws before proceeding to the next step.

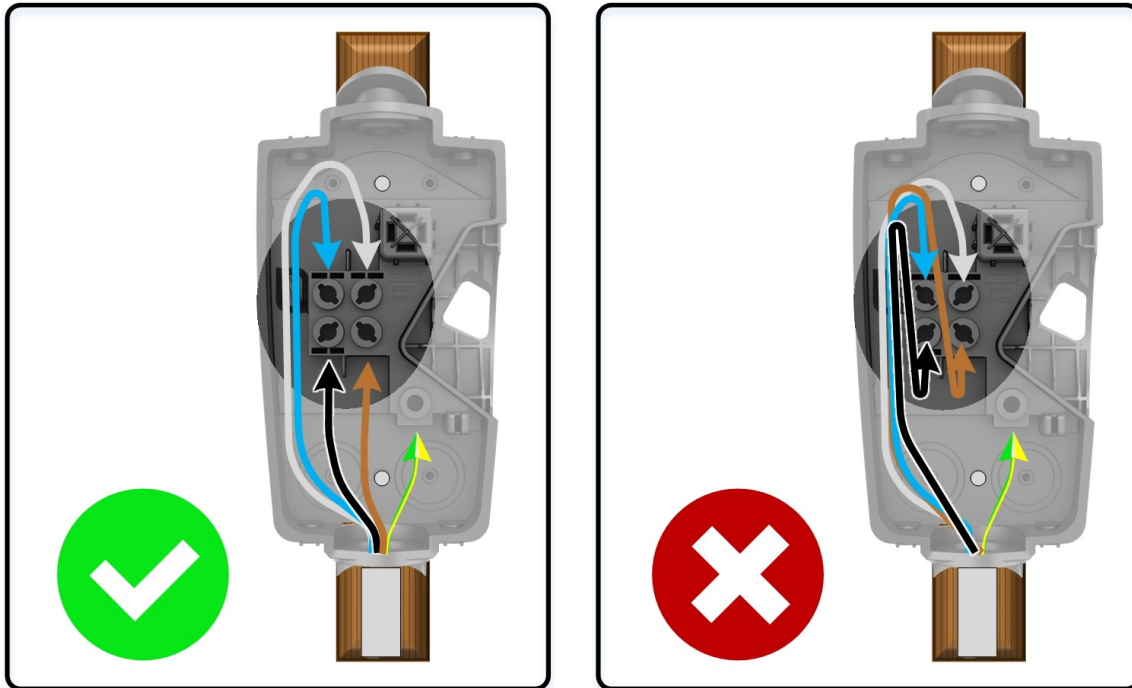

NOTE: Rear of Wall Connector has a sensor to monitor the terminal block, any obstruction from wiring or zip tie can interfere with Wall Connector operation.



## INSTALLATION STEPS

### STEP 6: Securing Main Unit to Wirebox

1. Attach the main unit to the wirebox.



2. Secure the main unit to the wirebox with the 4 included fasteners using the included bit. Use a bit driver to hand-tighten the fasteners.







## COMMISSIONING PROCEDURE

The commissioning process for Wall Connector enables easy configuration of circuit breaker size, Wi-Fi connectivity, and power sharing options. Wall Connectors must be commissioned before first use.

1. Turn on Wall Connector's corresponding circuit breaker to energize the unit.
2. Use a Wi-Fi-enabled device such as a smart phone to connect to the SSID Wi-Fi signal broadcasted by the Wall Connector. Joining the Wall Connector network can be done by scanning the sticker QR code on the Quickstart Guide cover page, or by manually selecting the network and typing in the WPA2 password (found on the sticker on the Quickstart Guide cover page).

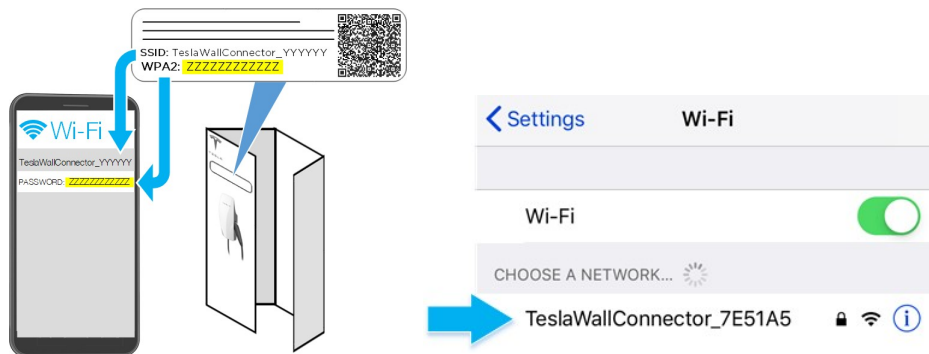
 NOTE: SSID will broadcast for 15 minutes.



 NOTE: If you are unable to connect to the Wall Connector SSID, turn off the cellular data function on your mobile device and try again.

 NOTE: If the Wall Connector has not been commissioned, a solid yellow light will display on the front of the main unit to indicate that it is ready to be commissioned.

3. Scan the QR code below with the device that is connected to the Wall Connector to access the web browser commissioning interface. Alternatively, manually type the URL address (<http://192.168.92.1>) into the web browser.

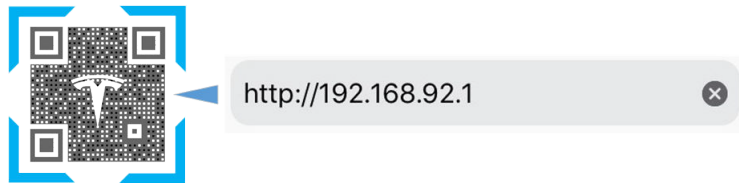

4. Follow the onscreen commissioning steps on the web browser.

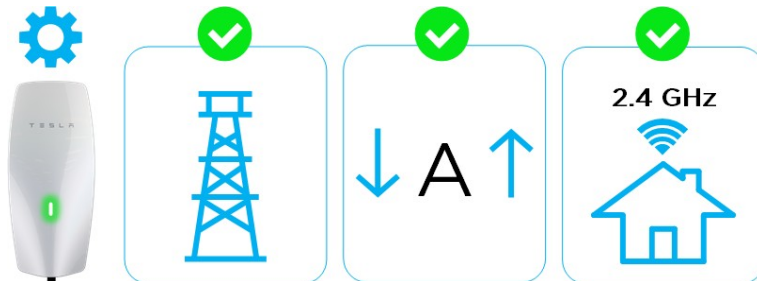



## COMMISSIONING PROCEDURE



NOTE: To have the Wall Connector broadcast the SSID again, hold the button on the charge handle for 5 seconds or turn the circuit breaker off, then on again.





# POWER SHARING

## Power Sharing Overview

The firmware-based power sharing feature enables up to 6 Wall Connectors installed at the same site to intelligently share the site's total available power via unit-to-unit Wi-Fi. This minimizes the need for many residential and commercial applications to have specific electrical upgrades for concurrent multi-vehicle charging.

During the commissioning process,

- Wall Connectors are allocated to individual branch circuits (each up to 60 amps)
- Total power is allocated to the group of linked Wall Connectors



NOTE: For instructions to commission Wall Connectors in a power sharing network, see [Gen 3 Wall Connector Power Sharing](#).

Total current output of Wall Connectors that share power will never exceed the site's total allocated power.

1. AC feed (service panel)
2. Power sharing via Wi-Fi communication



## Breaker and Branch Circuit Setup

Power sharing circuits may be installed in an electrical panel that supports other loads. If space is limited or the main power supply is far from the Wall Connectors, installing a dedicated load center may be prudent.

See below for examples of Wall Connector power sharing diagrams (one with sub-panel and one without). Each individual Wall Connector in below examples is capable of providing 48 amps when it is the only one in use. As more Wall Connectors begin plugging into vehicles, the system will automatically distribute power based on the total power allocated to the site.

### Power Sharing Setup with Sub-Panel

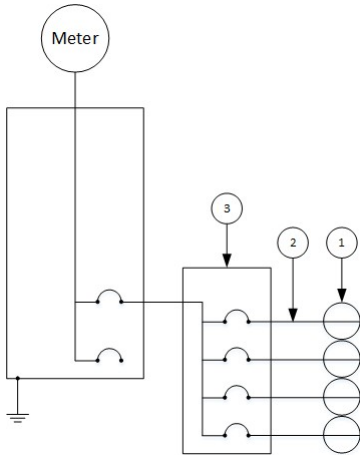

1. Wall Connector
2. 60 A branch circuit
3. 100 A sub-panel / feeder breaker

### Power Sharing Setup Without Sub-Panel

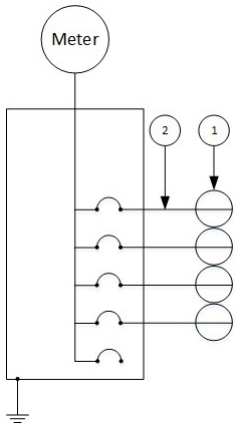

1. Wall Connector
2. 60 A branch circuit



## Considerations for Power Sharing

Wall Connector power sharing is achieved wirelessly.

For optimal performance, Wall Connectors within a power sharing network should be installed within view of each other whenever possible.

 NOTE: Line of sight is recommended but not required. Wireless communication is capable of reaching around concrete corners but network range may degrade as a result.

Avoid placing Wall Connectors on opposite sides of concrete, masonry, metal studs, and other physical obstructions that would impede Wi-Fi signal strength.

 NOTE: If a mobile device is able to connect to the Leader Wall Connector Wi-Fi, it is a good indication that the Follower Wall Connector will also be able to connect.

## Calculating Power Sharing Requirements for Existing Systems

To calculate power supply requirements per number of Wall Connectors for existing electrical systems, use the following equation:

Available continuous amperage:	Number of Wall Connectors:	Max amperage output per Wall Connector when 100% utilized:
_____	_____	_____
÷		=
_____		

 NOTE: Maximum number of Wall Connectors for power sharing is 6.

 NOTE: When calculating maximum amperage per Wall Connector, 100% utilization must be greater than 6 amps for power sharing operation. If maximum amperage is greater than 48 amps, power sharing is not necessary.

For large scale sites, consider expected parking time in relation to a 100% utilization rate.

Expected Park Time (hours)	Examples	Recommended Amperage per wall Connector at 100% Utilization
6+ (long term)	Long term parking, overnight parking	12+ amps
3-5 (medium term)	Workplace, hospitality	24+ amps
1-2 (short term)	Shopping and dining	32+ amps

 NOTE: 100% utilization represents the worst case scenario for charging speeds, where the least amount of power would be available for each individual vehicle. In most situations, not all Wall Connectors would be actively charging a vehicle, which enables faster charging for the remaining vehicles.



## WALL CONNECTOR LEDS

### Light Codes

#### Startup

Once energized at the circuit breaker, every LED (seven total) on the faceplate will illuminate for up to five seconds.

#### Other

After startup, waiting for commissioning	Standby, waiting to plug in	Charging in progress	SSID broadcasting, ready to commission	Waiting to charge, communicating with vehicle
Solid yellow (green + red)	Top green solid	Every green streaming	Green pulsing	Blue solid
				



NOTE: If a red dot is displayed, connect to Wall Connector Commissioning or see next table for all error codes.



## Error Codes

All red blink codes pause for one second, and then repeat.		
Light Bar	What It Means	Details
No Lights	Power supply issue, charging disabled	Verify that the power supply is turned on. If the issue persists, have an electrician remove the Wall Connector from the wirebox and confirm that voltage is present at the terminal block using a multimeter. Record measurements at terminals of wirebox.
Solid yellow	Wall Connector is ready to be commissioned	See <a href="#">Commissioning Procedure on page 28</a> to commission the Wall Connector.
Solid red	Internal error, charging disabled	Turn the circuit breaker off, wait 5 seconds, and turn it back on. If solid red light remains, document part number and serial number, then contact Tesla Energy.
One (1) red blink	Earth fault circuit interruption due to unsafe current path, charging disabled	Inspect the handle, cable, Wall Connector, and vehicle charge port for damage or signs of water ingress. Contact Tesla Energy if power supply has been checked and confirmed as okay by an electrician.
Two (2) red blinks	Earth assurance fault, high earth resistance detected, charging disabled	Verify that the Wall Connector is properly connected to earth. The earth connection must be bonded in the upstream power supply for proper operation. Check all physical connections, including the wirebox terminals, electrical panel(s), and junction boxes. If connected to a transformer, contact the transformer's manufacturer for direction on how to bond the earth connection. If charging on a IT or TT grid, check ground monitor settings.
Three (3) red blinks	High temperature detected; charging limited or disabled	Verify that Wall Connector is connected to Wi-Fi and updated with the latest available firmware for optimal temperature sensing functionality. Check the faceplate and cable handle for excessive warmth. Have an electrician remove the Wall Connector from the wirebox and verify that the conductors used are sized correctly and that the terminal block is torqued to specification. Connect Wall Connector to Wi-Fi so that firmware can update to most recent version. If firmware does not automatically update, use the <a href="#">Commissioning Procedure on page 28</a> to sign into the commissioning wizard and manually update the firmware. If it does not solve the problem, contact our Customer Support team.
Four (4) red blinks	Internet connection lost, online features disabled	Check for objects that could interfere with the area's Wi-Fi signal strength. Confirm that the local Wi-Fi router is operational. If the Wi-Fi password was changed recently, follow the commissioning process on your mobile device to update the Wi-Fi settings.
Five (5) red blinks	Power-sharing communication issue, charging reduced	Check for objects that could interfere with the area's Wi-Fi signal strength. Follow the commissioning process on your mobile device to re-link the Wall Connectors for power-sharing.
Six (6) red blinks	Overvoltage or poor grid quality detected, charging disabled	Connect to Wall Connector with commissioning process to view live voltage info. If the issue persists, have an electrician remove the Wall Connector from the wirebox and confirm that voltage readings are as expected at the terminal block using a multimeter. Record voltage readings at terminals.



## WALL CONNECTOR LEDS

All red blink codes pause for one second, and then repeat.

Light Bar	What It Means	Details
Seven (7) red blinks	Vehicle overcurrent detected	Reduce the vehicle's charge current setting. If the issue persists and the attached vehicle is manufactured by Tesla, record the vehicle's VIN and approximate time of the fault and contact Tesla. If the vehicle is not manufactured by Tesla, contact the vehicle's manufacturer.



## CHARGING EQUIPMENT LIMITED WARRANTY

Subject to the exclusions and limitations described below, this Charging Equipment Limited Warranty covers the refund, repair or replacement necessary to remedy any manufacturing defects in a Tesla manufactured and supplied Wall Connector that occur under normal personal use for a period of 48 months, or a period of 12 months for normal commercial use\*, and a Tesla manufactured and supplied Mobile Connector or charging adapter that occur under normal use for a period of 12 months, starting from the date of invoice to the customer for any charging equipment. Any Tesla manufactured and supplied connector or adapter included in the initial purchase and delivery of a Tesla vehicle by Tesla is covered under the Basic Vehicle Limited Warranty section of the New Vehicle Limited Warranty for 4 years or 50,000 miles (80,000 km), whichever comes first, subject to the terms and conditions of the New Vehicle Limited Warranty.

\*For warranty claims specific to Wall Connectors, “commercial use” means Wall Connectors used for purposes other than charging at a residential single family home for daily personal use, which includes, but is not limited to, charging at hotels, offices, parking lots and complexes (including apartment, condominiums and other multi-family or unit dwellings), and retail and other locations that allow (including by being listed online or publicly) for pay-for-use charging, or are located where users other than the owner could reasonably obtain access to the Wall Connector.

This Charging Equipment Limited Warranty does not cover any damage or malfunction directly or indirectly caused by, due to, or resulting from, normal wear or deterioration, abuse, misuse, negligence, accident, lack of or improper installation, use, maintenance, storage or transport, including, but not limited to, any of the following:

Failure to follow the instructions, operation, maintenance and warnings published in the documentation supplied with your Tesla connector or adapter;

External factors, including but not limited to, objects striking the Tesla connector or adapter, faulty or damaged electrical wiring or connections, external electrical faults, junction boxes, circuit breakers, receptacles or power outlets, the environment or an act of God, including, but not limited to, fire, earthquake, water, lightning and other environmental conditions;

General appearance or damage to paint, including chips, scratches, dents and cracks;

Failure to contact Tesla upon discovery of a defect covered by this Charging Equipment Limited Warranty;

Any repair, alteration or modification to the Tesla connector or adapter or any part, or the installation or use of any parts or accessories, made by a person or facility not authorized or certified to do so; and

Lack of or improper installation, repair or maintenance, including use of non-genuine Tesla accessories or parts.

Although Tesla does not require you to perform all maintenance, service or repairs at a Tesla Service Center or Tesla authorized repair facility, this Charging Equipment Limited Warranty may be voided, or coverage may be excluded, due to lack of or improper maintenance, service or repairs. Tesla Service Centers and Tesla authorized repair facilities have special training, expertise, tools and supplies with respect to Tesla connectors and adapters and, in certain cases, may employ the only persons, or be the only facilities authorized or certified to work on Tesla connectors and adapters. Tesla strongly recommends that you have all maintenance, service and repairs done at a Tesla Service Center or Tesla authorized repair facility in order to avoid voiding, or having coverage excluded under, this Charging Equipment Limited Warranty.



## LIMITS OF LIABILITY

Subject to any non-excludable statutory guarantees as set out in the Country Specific Disclosures Appendix below and to the maximum extent permitted by law, this Charging Equipment Limited Warranty is the only express warranty made in connection with your Tesla connector or adapter. Implied and express warranties and conditions arising under applicable local laws, federal statute or otherwise, in law or in equity, if any, including, but not limited to, implied warranties and conditions of merchantability or merchantable quality, fitness for a particular purpose, durability, or those arising by a course of dealing or usage of trade, or any warranties against latent or hidden defects, are disclaimed to the fullest extent allowable by your local law, or limited in duration to the term of this Charging Equipment Limited Warranty. To the fullest extent allowable by your local law, the performance of necessary repairs and/or replacement of new, reconditioned, or remanufactured parts by Tesla for the covered defects is the exclusive remedy under this Charging Equipment Limited Warranty or any implied warranties. To the maximum extent permissible under your local law, liability is limited to the reasonable price for repair or replacement of the applicable Tesla connector or adapter, not to exceed the manufacturer's suggested retail price. Replacement may be made with parts of like kind and quality, including non-original manufacturer's parts, or reconditioned or remanufactured parts, as necessary. This Charging Equipment Limited Warranty covers only parts and factory labor necessary to repair but does not include any on-site labor costs related to un-installing, reinstalling or removing the repaired or replacement charging equipment. Parts repaired or replaced, including replacement of a Tesla connector or adapter, under this Charging Equipment Limited Warranty are covered only until the applicable warranty period of this Charging Equipment Limited Warranty ends. Under no circumstances will the original warranty period be extended as a result of your Tesla connector or adapter being repaired or replaced.

Tesla shall not be liable for any defects under this Charging Equipment Limited Warranty that exceed the fair market value of the applicable Tesla connector or adapter at the time immediately preceding the discovery of the defect. In addition, the sum of all benefits payable under this Charging Equipment Limited Warranty shall not exceed the price you paid for the applicable Tesla connector or adapter.

Tesla does not authorize any person or entity to create for it any other obligations or liability in connection with this Charging Equipment Limited Warranty. Subject to local laws and regulations, the decision of whether to repair or replace a part or to use a new, reconditioned or remanufactured part will be made by Tesla, in its sole discretion. Tesla may occasionally offer to pay some or all of the cost of certain repairs that are not covered by this Charging Equipment Limited Warranty, either for specific models or on an ad hoc, case-by-case basis. Tesla reserves the right to do the above at any time without incurring any obligation to make a similar payment to other Tesla charging equipment owners.

To the maximum extent permissible under local law, Tesla hereby disclaims any and all indirect, incidental, special and consequential damages arising out of, or relating to, the Tesla connector or adapter, including, but not limited to, transportation to and from a Tesla Authorized Service Center, loss of the Tesla connector or adapter, loss of vehicle value, loss of time, loss of income, loss of use, loss of personal or commercial property, inconvenience or aggravation, emotional distress or harm, commercial loss (including but not limited to lost profits or earnings), towing charges, bus fares, vehicle rental, service call charges, gasoline expenses, lodging expenses, damage to tow vehicle, and incidental charges such as telephone calls, facsimile transmissions, and mailing expenses.

The above limitations and exclusions shall apply whether your claim is in contract, tort (including negligence and gross negligence), breach of warranty or condition, misrepresentation (whether negligent or otherwise), or otherwise at law or in equity, even if Tesla is advised of the possibility of such damages or such damages are reasonably foreseeable.

Nothing in this Charging Equipment Limited Warranty shall exclude, or in any way limit, Tesla's liability for death or personal injury solely and directly caused by Tesla's negligence, or that of its employees, agents or sub-contractors (as applicable), fraud or fraudulent misrepresentation, or any other liability to the extent the same is proven in a court of competent jurisdiction in a final nonappealable judgment and may not be excluded or limited as a matter of local law.





# CLAIMING UNDER THE CHARGING EQUIPMENT LIMITED WARRANTY

## Australia

In Australia, the Charging Equipment Limited Warranty is given by Tesla Motors Australia, Pty Ltd.

## New Zealand

In New Zealand, the Charging Equipment Limited Warranty is given by Tesla New Zealand ULC.

## Claim Procedure

To make a claim under the Charging Equipment Limited Warranty you will need to:

1. Contact Tesla at the address, email address or telephone numbers listed below for the country in which the Wall Connector was purchased.
2. Provide the following information when contacting the Tesla certified installer who sold you your Wall Connector or Tesla:
  - a. your name and contact information;
  - b. proof of the original purchase of your Wall Connector and any subsequent transfer of ownership;
  - c. your Wall Connector's part number, serial number and original installation date; and
  - d. a description of the alleged defect(s) or LED error codes listed on page 34 of this manual and any attempts made to resolve the concerns, including any attempted repairs or services not performed by or on behalf of Tesla.

If you make a claim in accordance with the above claim procedure and a fault with your Wall Connector is covered by the terms of the Charging Equipment Limited Warranty, Tesla will bear the cost of repairs to or replacement of your Wall Connector as well as transport and re-installation costs of the Wall Connector and the costs of any at-home or on-site inspection of the Wall Connector that was required to diagnose the fault. All other expenses of claiming under the Charging Equipment Limited Warranty will be borne by you. For the avoidance of doubt, the costs of any at-home or on-site inspection, repairs to and replacement of the Wall Connector will be borne by you if any reported concern with your Wall Connector is not covered by the Charging Equipment Limited Warranty or if a warrantable fault is found but you elect to have the fault rectified by a third party that is not approved by Tesla, unless you are entitled to those costs under applicable laws, including without limitation the Australian Consumer Law and the Consumer Guarantees Act 1993 (NZ).

If your Wall Connector is replaced under the Charging Equipment Limited Warranty, the remainder of the original warranty period under that warranty will apply to the replacement product, subject to any non-excludable rights and remedies you have under local laws in your country or region in respect of the repaired or replacement product.

## Contact Details

### *Australia:*

Tesla Motors Australia, Pty Ltd

Level 14, 15 Blue Street

North Sydney NSW 2060

Phone: 1800 646 952 (Toll Free)

### *New Zealand*



Tesla New Zealand ULC

501 Karangahape Road

Auckland, 1010

New Zealand

Phone: 0800 005 431 (Toll Free)



## DISPUTE RESOLUTION

Tesla requires that you first provide written notification of any manufacturing defect within a reasonable time, and within the applicable coverage period specified in this Charging Equipment Limited Warranty, and allow Tesla an opportunity to make any needed repairs in accordance with the claim procedure set out above before submitting a dispute to our dispute settlement program (described below). Please send written notification on dispute resolution to the following address:

### Vehicles registered in Australia:

Tesla Motors Australia, Pty Ltd ACN 142

889 816

Level 14, 15 Blue Street

North Sydney NSW 2060

Australia Phone: 1800 646 952

### Vehicles registered in New Zealand:

Tesla New Zealand ULC (6018628)

501 Karangahape Road

Auckland, 1010

New Zealand

Phone: 0800 005 431 (Toll Free)

### Please include the following information:

- Tesla Part Number and Serial Number
- Your name and contact information
- Name and location of the Tesla Store and/or Tesla Service Center nearest to you
- Description of the defect
- History of the attempts you have made with Tesla to resolve the concern, or of any repairs or services that were not performed by Tesla
- In the event any disputes, differences, or controversies arise between you and Tesla related to this Charging Equipment Limited Warranty, Tesla will explore all possibilities for an amicable settlement



## Appendix – Country Specific Disclosures

### Australia

The Charging Equipment Limited Warranty is provided in addition to, and does not exclude, restrict, modify or limit any other rights and remedies you have under a law in relation to the Wall Connector to which the Charging Equipment Limited Warranty relates, including the Australian Consumer Law.

The following statement applies to Australian purchases of Wall Connectors where the Australian Consumer Law applies:

Our goods come with guarantees that cannot be excluded under the Australian Consumer Law. You are entitled to a replacement or refund for a major failure and compensation for any other reasonably foreseeable loss or damage. You are also entitled to have the goods repaired or replaced if the goods fail to be of acceptable quality and the failure does not amount to a major failure.

### New Zealand

The Charging Equipment Limited Warranty is provided in addition to, and does not exclude, restrict, modify or limit any rights you have under the Consumer Guarantees Act 1993 (NZ) and the Fair Trading Act 1986 (NZ) (together, the **New Zealand Consumer Laws**).

If a Wall Connector is acquired for the purposes of a business then the Consumer Guarantees Act 1993 (NZ) shall not apply to the sale and purchase of that Wall Connector.

Your right under the New Zealand Consumer Laws may also apply to any repaired or replacement Wall Connector.

TESLA

Revision 1.0